



Easy to fill and very price attractive

# easy chain<sup>®</sup>

CHAINFLEX<sup>®</sup>



# easy chain® - easy to fill and very price attractive

easy chains® are available with exterior (version E) press fit access, as well as interior (version Z) access. The assembly time reductions are a primary reason to choose easy chains®. Their material, igumid NB, presents more application opportunities with: Optimal elasticity, UL94-V2 classification and excellent cleanroom qualities. Their one-piece design keeps the easy chain® very price-effective

## Typical industries and applications

- General machinery
- Cleanroom applications
- Electronic apparatus
- Office equipment
- Vending machines
- Packaging machines



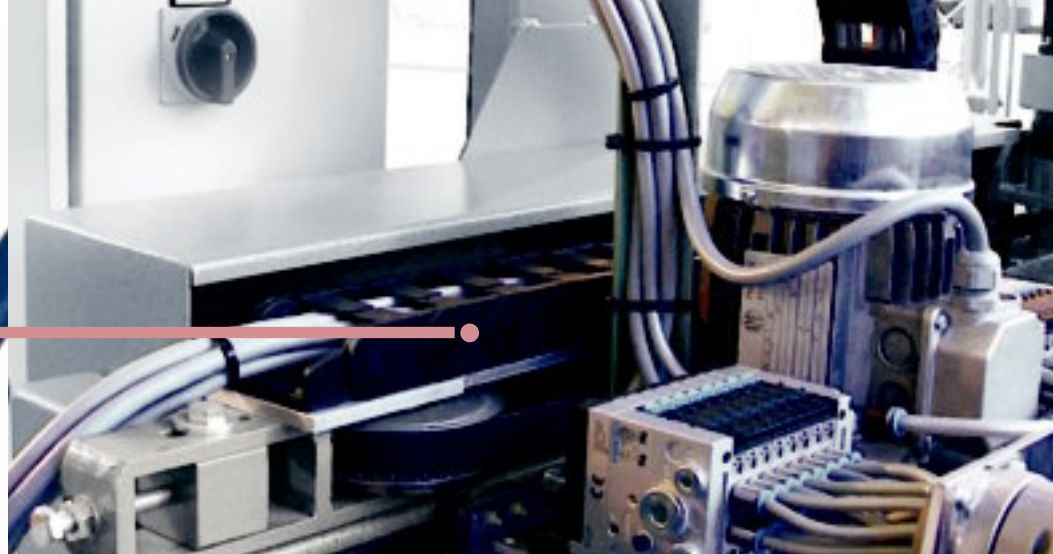

Machinery of all kinds feature igus® easy chains® - reduces assembly times



Clean room test acc. to Fraunhofer Institute IPA

Standard material - ISO Class 2 acc. to ISO 14644-1

Speed:  $v = 1,0 \text{ m/s}$  and  $a = 2,0 \text{ m/s}^2$  - Series E14.3.038



easy chain® with electricity conducting material  
igumid ESD for ESD/ATEX applications upon request.  
Delivery time: 3-5 days



UL94-V2  
classifications



With easy chain® rotatory and  
torsional motions are possible



42 dB(A) - Value determined at the igus® test-lab:  
 $v = 1,0 \text{ m/s}$  unsupported, Series E06.10.038.0

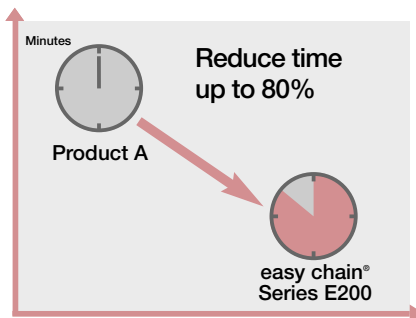

Assembly time: Insert of 2 cables  $\varnothing 6$  and  $10 \text{ mm}$ .

We can present you with more details about this and other tests

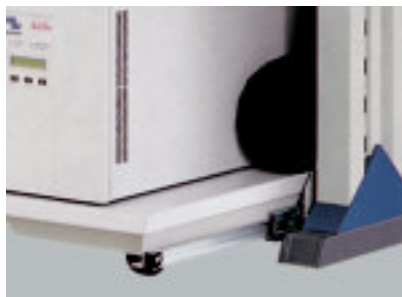

easy chain® Series E14 on server unit, removable for maintenance purposes Cleanroom Class 2 ISO is standard



easy chain® on adjustable office furniture with UL94 - V2 Classification

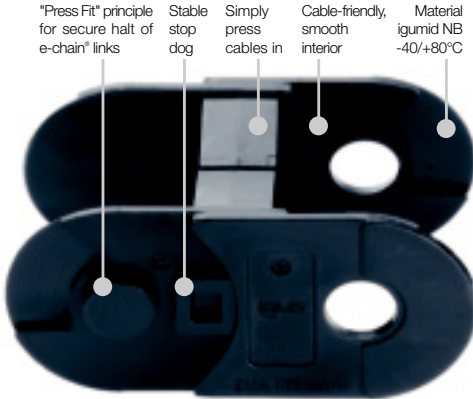

**easy chain®: "E" and "Z" makes "easy"**

- Easy to fill from the inner radius (Version "Z") or outer (exterior) radius (Version "E")
- Fast cable accessibility without opening and closing lids
- Easy to lengthen and shorten at any point
- Low price with one-piece design
- Dirt-repellent, contoured exterior
- Mounting brackets available with integrated strain relief
- Limited torsion tolerance
- Available with interior separation (some types)
- Flammability rating UL94-V2
- Suitable for clean-room applications
- You can find more technical data about the material, chemical resistance, temperatures ► **chapter design, from page 1.38**

**Selection table**

Series	Inner height <i>hi</i> [mm]	Inner width <i>Bi</i> [mm]	Outer width <i>Ba</i> [mm]	Outer height <i>ha</i> [mm]	Bending radius <i>R</i> [mm]	Unsupported length max. [m]	Page
E03	5	5 - 10	8,7 - 13,7	8	10 - 28	0,40	3.6
E04	7	7	13	10	15 - 48	0,55	3.10
E045-Z045	9,4	10 - 27	16 - 37	12,5	18 - 38	0,40	3.14
E06-Z06	10,5 / 10,7	10 - 20	16,5 - 26,5	15	18 - 38	0,55	3.20
E065/Z065	11,3	16 - 36	24,8 - 49,3	15	18 - 38	0,60	3.24
E08-Z08	14,6 / 14,7	10 - 50	18,2 - 58,2	19,3	28 - 48	1,00	3.28
E14-Z14	19	15 - 50	27 - 62	25	28 - 125	0,65	3.32
E200-Z200	24,3	37 - 57	74,4 - 120,4	35	55 - 200	1,75	3.36
E16-Z16	32	23 - 100	37,5 - 115,3	39	40 - 100	1,00	3.42
E26-Z26	36,5 / 37,1	47 - 75	92 - 167	50	63 - 250	2,00	3.46
E300-Z300	48,5	46 - 75	95 - 170	64	75 - 300	2,25	3.52

**Quick assembly with ESD!**

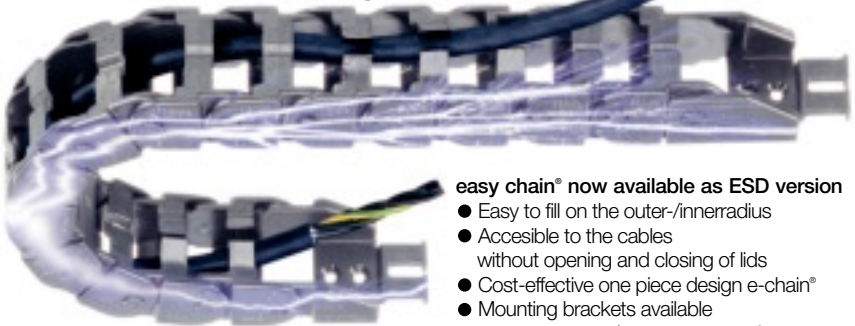

**easy chain® now available as ESD version**

- Easy to fill on the outer-/innerradius
  - Accessible to the cables without opening and closing of lids
  - Cost-effective one piece design e-chain®
  - Mounting brackets available
- More information ► [www.igus.eu/esd](http://www.igus.eu/esd)**

**Assembling | Separating | Filling** | Series E03 · E04 · E/Z045



Twist and click or twist and divide



Press in cable

**Assembling** | Series E/Z06 · E/Z065 · E/Z08 · E/Z14 · E/Z200 · E/Z16 · E/Z26 · E/Z300



Push and click...



Snap in pin

**Separating** | Series E/Z06 · E/Z065 · E/Z08 · E/Z14 · E/Z200 · E/Z16 · E/Z26 · E/Z300



Release side link



Twist and pull apart

**Filling** | Series E/Z06 · E/Z065 · E/Z08 · E/Z14 · E/Z200 · E/Z16 · E/Z26 · E/Z300



Press in cable



Pull out cable





Price index



IPA Qualification Certificate:  
Air Cleanless Class ISO Class 2  
(at v = 1 m/s) upon request



UL94-V2 classifications



Torsional  
motion possible



Smallest inner heights 5 mm:  
Series E03 easy chain®

- ① igus® smallest e-chain® - interior dimensions 5 x 5 mm
- ② Very easy to fill - ideal for harnessed cable assemblies, without opening and closing lids
- ③ Mounting bracket with integrated strain relief
- ④ Small pitch for low-noise, smooth operation
- ⑤ Very light weight - ideal for low fill weight
- ⑥ For smallest bending radii Chainflex® CF98/CF99 - 4 x d!
- ⑦ Low price
- ⑧ The patented push-button principle holds the links together



Adapter plate  
for rapid installation



Just push the cables into the e-chain®  
with your thumb - and it's ready



When to use the Series E03:

- If filling is required without opening and closing lids
- If price is an issue
- If quiet operation is required



When not to use it:

- Applications with very high loads and long unsupported lengths
  - ▶ Series 04 E2 micro, page 5.18
- If an e-chain® is needed, which is not to open
  - ▶ Series 03 E2 micro, page 5.12



Order example complete e-chain®

Please indicate chain-lengths or number of links Example: 1 m or 100 links

1 m E03.05.010.0

 e-chain®

1 set E03.05.12Z

 Mounting bracket



### Unsupported length

$FL_G$  = with straight upper run

$FL_B$  = with permitted sag

Further information ► **Design, page 1.12**

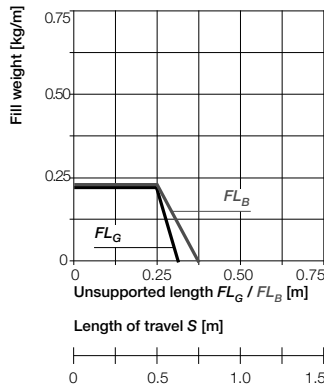
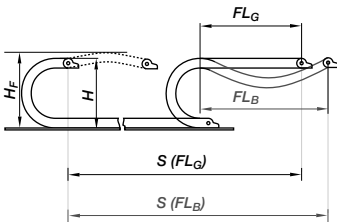

- $S$  = Length of travel
- $R$  = Bending radius
- $H$  = Nominal clearance height
- $H_F$  = Required clearance height
- $D$  = Overlength e-chain\*  
radius in final position
- $K = \pi \cdot R + \text{"safety"}$

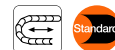
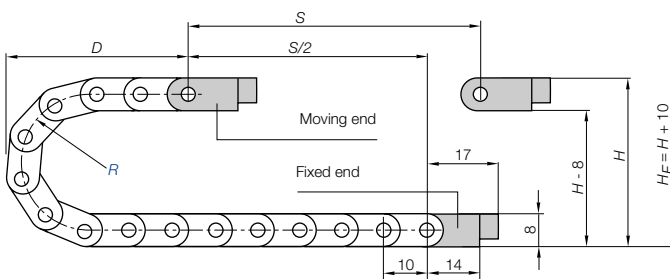

### Short travels - unsupported

Unsupported e-chains\* feature positive camber over short travels. This must be accounted for when specifying the clearance height  $H_F$ . Please consult igus® if space is particularly restricted.

Pitch = 10 mm/link    Links/m = 100 (1.000 mm)    Chain length =  $S/2 + K$

R	010	012	015	018	028
H	28	32	38	44	64
D	29	31	34	37	47
K	55	60	70	80	110

The required clearance height:  
 $H_F = H + 10$  mm  
 (with 0,1 kg/m fill weight)

Speed / acceleration $FL_G$	max. 20 [m/s] / max. 200 [m/s <sup>2</sup> ]
Speed / acceleration $FL_B$	max. 3 [m/s] / max. 6 [m/s <sup>2</sup> ]
Gliding speed / acceleration (maximum)	max. 3 [m/s] / max. 10 [m/s <sup>2</sup> ]
Material (e-chain)* - permitted temperature °C	igumid NB / -40° up to +80° C
Material (mounting brackets)* - permitted temperature °C	igumid G / -40° up to +120° C
Flammability class (e-chain)*, igumid NB	VDE 0304 IIC UL94 V2
Flammability class (mounting brackets), igumid G*	VDE 0304 IIC UL94 HB

\*Available in igumid NB upon request, please consult igus® for delivery time

### Technical Data



Details of material properties  
 ► page 1.38



easy chain®  
 Inner height: 5 mm

Phone +49- (0) 22 03-96 49-800  
 Fax +49- (0) 22 03-96 49-222



► page 3.5



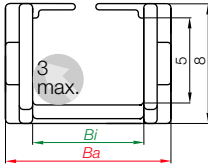

Part No. structure

E03.	05.	010.	0
		Color black	
		Bending radius	
		Width	
		Series	

## Series E03 - split crossbar along the outer radius

Part No.	$B_i$ [mm]	$B_a$ [mm]	$R$ [mm]	Bending radii					Weight [kg/m]
E03.05. <input type="text"/> .0*	5	8,7	<input type="text"/> 010	<input type="text"/> 012	<input type="text"/> 015	<input type="text"/> 018	<input type="text"/> 028	≈ 0,03	
E03.07. <input type="text"/> .0*	7	10,7	<input type="text"/> 010	<input type="text"/> 012	<input type="text"/> 015	<input type="text"/> 018	<input type="text"/> 028	≈ 0,04	
E03.10. <input type="text"/> .0*	10	13,7	<input type="text"/> 010	<input type="text"/> 012	<input type="text"/> 015	<input type="text"/> 018	<input type="text"/> 028	≈ 0,05	

**Ba:** pin dimension approx. 0,1 - 0,3 mm wider!

\*Crossbars do not overlap! Gap: E03.05. = 1 mm, E03.07. = 2 mm, E03.10. = 2 mm

Supplement Part No. with required radius. Example: E03.05.  010.0

0 = standard color, other colors ► page 1.39 · Pitch = 10 mm/link - Links/m = 100





**Polymer, one-piece**

- One-piece mounting bracket
- Corrosion-resistant
- Available preassembled
- Inner and outer attachment possible
- Adapter plate for rapid installation

Moving end with bore (outer link) 03...1Z

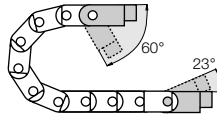

03...2Z Fixed end with pin (inner link)

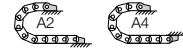

Possible installation conditions for assembled mounting brackets ▶ Order example "preassembled" below

03...2Z  
Fixed end

03...1Z  
Moving end

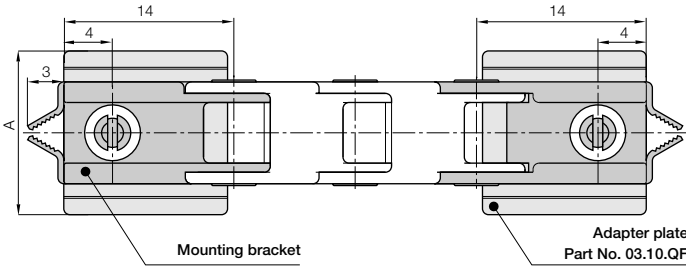

**Dimensions and order configurations**

For e-chain®	Part No. full set	Dim. A [mm]
E03.05. ▶	03.05. <b>12Z</b>	8,7
E03.07. ▶	03.07. <b>12Z</b>	10,7
E03.10. ▶	03.10. <b>12Z</b>	13,7

For the **preassembled** mode please add the index **A2** or **A4** e.g. 03.05. **12Z** **A2**

Part No. structure

03. 05. 12Z A2

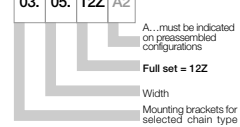

**03.10.QF = Adapter plate for all sizes**

The adapter has broken edges, so that it can be adapted to the respective chain width. It is not absolutely necessary for attaching the mounting brackets. The mounting brackets can also be screwed on without the adapter plate.

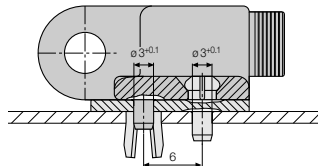

Full set, for both ends:

03. 05. **12Z**

Single-part order:

03. 05. **1Z**

Mounting bracket with bore

03. 05. **2Z**

Mounting bracket with pin



Adapter plate for rapid installation upon request Part No. 03.10.QF

**Additional Features**

Phone +49- (0) 22 03-96 49-800  
Fax +49- (0) 22 03-96 49-222





Price index



IPA Qualification Certificate:  
Air Cleanless Class ISO Class 2  
(at v = 1 m/s) upon request



UL94-V2  
classifications



Torsional  
motion possible



Special equipment:  
Electrically conductive ESD/ATEX  
version upon request

- ① Very easy to fill - ideal for harnessed cable assemblies
- ② Small pitch for low-noise, smooth operation
- ③ For high acceleration
- ④ Limited torsion tolerance
- ⑤ Cable -friendly smooth interior
- ⑥ Mounting brackets available
- ⑦ The patented push-button principle holds the links together



Special solution -  
opening gap 0,8 mm  
Part No. E04.07.015.S



Just push the cables into the e-chain®  
with your thumb - and it's ready



When to use the Series E04:

- If filling is required without opening and closing lids
- If price is an issue
- If quiet operation is required



When not to use it:

- For applications with very high loads and long unsupported travel lengths
  - ▶ Series 06 E2 micro, page 5.36
- If an e-chain® is needed, which is not to open
  - ▶ Series 04 E2 micro, page 5.18



Order example complete e-chain®

Please indicate chain-lengths or number of links Example: 1 m or 60 links

1 m E04.07.038.0



e-chain®

1 set 040.07.12



Mounting bracket



**Unsupported length**

$FL_G$  = with straight upper run

$FL_B$  = with permitted sag

Further information ► **Design, page 1.12**

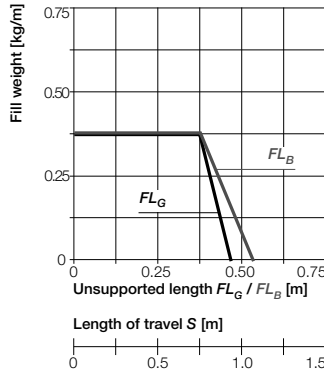
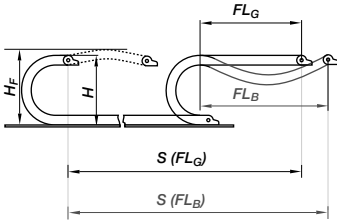

- $S$  = Length of travel
- $R$  = Bending radius
- $H$  = Nominal clearance height
- $H_F$  = Required clearance height
- $D$  = Overlength e-chain\* radius in final position
- $K = \pi \cdot R + \text{"safety"}$

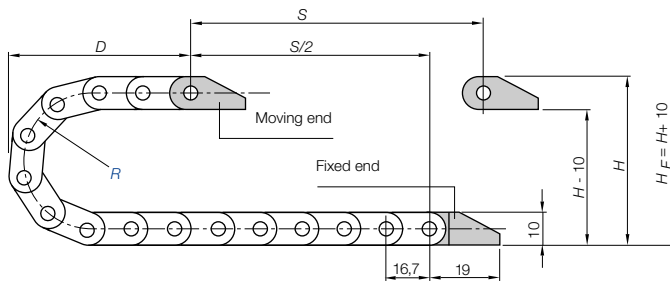

**Pitch = 16,7 mm/link    Links/m = 60 (1.002 mm)    Chain length =  $S/2 + K$**

R	015	018	028	038	048
H	40	46	66	86	106
D	45	48	58	68	78
K	85	90	125	155	185

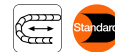

**Short travels - unsupported**

Unsupported e-chains\* feature positive camber over short travels. This must be accounted for when specifying the clearance height  $H_F$ . Please consult igus® if space is particularly restricted.

The required clearance height:  
 $H_F = H + 10$  mm  
 (with 0,1 kg/m fill weight)

Speed / acceleration $FL_G$	max. 20 [m/s] / max. 200 [m/s <sup>2</sup> ]
Speed / acceleration $FL_B$	max. 3 [m/s] / max. 6 [m/s <sup>2</sup> ]
Gliding speed / acceleration (maximum)	max. 3 [m/s] / max. 10 [m/s <sup>2</sup> ]
Material (e-chain*)- permitted temperature °C	igumid NB / -40° up to +80° C
Material (mounting brackets)* - permitted temperature °C	igumid G / -40° up to +120° C
Flammability class (e-chain*), igumid NB	VDE 0304 IIC UL94 V2
Flammability class (mounting brackets), igumid G*	VDE 0304 IIC UL94 HB

\*Available in igumid NB upon request, please consult igus® for delivery time

**Technical Data**



Details of material properties  
 ► page 1.38



easy chain®  
 Inner height: 7 mm

Phone +49- (0) 22 03-96 49-800  
 Fax +49- (0) 22 03-96 49-222



► page 3.5

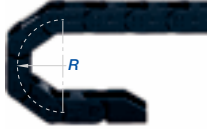
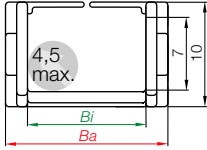

Part No. structure

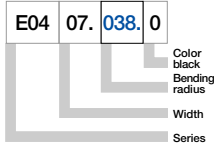

**Series E04 - split crossbar along the outer radius**

Part No.	Bi [mm]	Ba [mm]	R [mm]	Bending radii	Weight [kg/m]
E04.07.□.0*	7	13	015	018 028 038 048	≈ 0,08

**Ba:** pin dimension approx. 0,1 - 0,3 mm wider!

\*Crossbars do not overlap! Gap: E04.07. = 2,5 mm

Supplement Part No. with required radius. Example: E04.07.038.0

0 = standard color, other colors ▶ page 1.39 · Pitch = 16,7 mm/link - Links/m = 60





**Polymer, one-piece**

- One-piece mounting bracket
- Corrosion-resistant
- Available preassembled

Moving end with bore  
(outer link) 040...1(PZ)

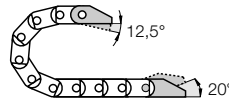

040...2(PZ) Fixed end  
with pin (inner link)

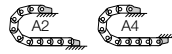

Possible installation conditions for assembled mounting brackets ► Order example "preassembled" below

040...1(PZ)  
Moving end

040...2(PZ)  
Fixed end

**Dimensions and order configurations**

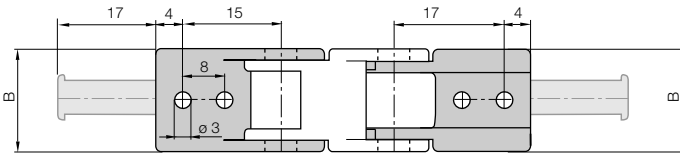

For e-chain®	Part No. full set with tiewrap plate	Part No. full set without tiewrap plate	Number of teeth	Dim. B [mm]
E04.07. ►	040.07. 12 PZ	040.07. 12	1	12

**Part No. structure**

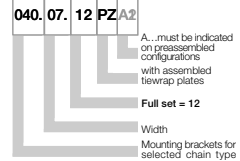

Full set, for both ends:

040.07.12.PZ +tiewrap plate

Single-part order:

040.07.1.PZ +tiewrap plate

Mounting bracket with bore

040.07.2.PZ +tiewrap plate

Mounting bracket with pin

For the preassembled mode please add the index A2...A4 e.g. 040.07.12.PZ.A2

Phone +49- (0) 22 03-96 49-800  
Fax +49- (0) 22 03-96 49-222



**Quicksnap** - the complete, detachable mounting unit, available upon request



**Quickfix** - mounting bracket with dowel, available upon request

**Additional Features**



► page 3.5

● ● ● Price index



IPA Qualification Certificate:  
Air Cleanless Class ISO Class 2  
(at v = 1 m/s) upon request



UL94-V2  
classifications



Torsional  
motion possible



Special equipment:  
Electrically conductive ESD/ATEX  
version upon request



Low-noise  
due small pitch



Just push the cables into the e-chain®  
with your thumb - and it's ready



When to use the Series E045/Z045:

- If filling is required without opening and closing lids
- If a very small pitch is required



When not to use it:

- For applications with very high loads and long unsupported travel lengths
  - ▶ Series 06 E2 micro, page 5.36
- If smooth operation is required
  - ▶ Series 045 E2 micro, page 5.24
- If high stability is required
  - ▶ Series 06 E2 micro, page 5.36

- 1 Very easy to fill
- 2 Small pitch for low-noise, smooth operation
- 3 Limited torsion tolerance
- 4 The patented push-button principle holds the links together
- 5 Cable-friendly interior
- 6 "E" Series features split crossbar along the outer radius
- 7 "Z" Series features split crossbar along the inner radius
- 8 Mounting bracket available
- 9 1-, 2- or 3-chamber system available

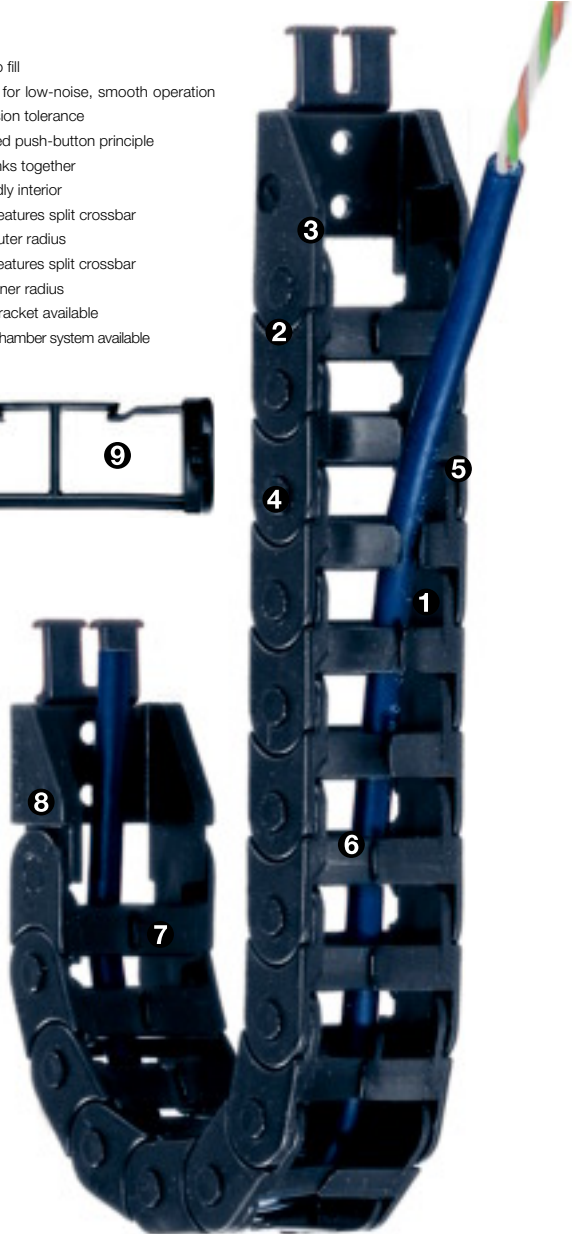

Order example complete e-chain®

Please indicate chain-lengths or number of links Example: 1 m or 77 links

1 m E045.16.038.0



e-chain®

1 set 0450.16.12



Mounting bracket



### Unsupported length

$FL_G$  = with straight upper run

$FL_B$  = with permitted sag

Further information ► Design, page 1.12

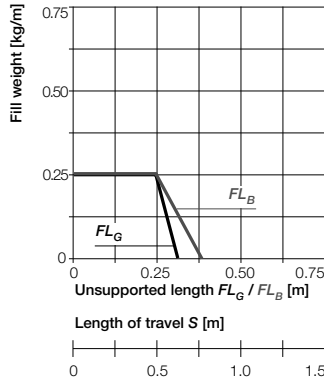
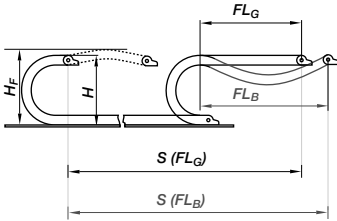

- $S$  = Length of travel
- $R$  = Bending radius
- $H$  = Nominal clearance height
- $H_F$  = Required clearance height
- $D$  = Overlength e-chain\*  
radius in final position
- $K = \pi \cdot R + \text{"safety"}$

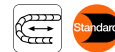
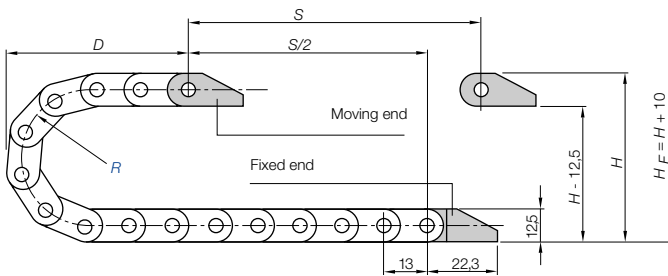

### Short travels - unsupported

Unsupported e-chains\* feature positive camber over short travels. This must be accounted for when specifying the clearance height  $H_F$ . Please consult igus® if space is particularly restricted.

Pitch = 13 mm/link    Links/m = 77 (1.001 mm)    Chain length =  $S/2 + K$

R	018	028	038
H	48,5	68,5	88,5
D	44	54	64
K	85	115	150

The required clearance height:  
 $H_F = H + 10$  mm  
(with 0,1 kg/m fill weight)

Speed / acceleration $FL_G$	max. 20 [m/s] / max. 200 [m/s]
Speed / acceleration $FL_B$	max. 3 [m/s] / max. 6 [m/s]
Gliding speed / acceleration (maximum)	max. 3 [m/s] / max. 10 [m/s]
Material (e-chain)* - permitted temperature °C	igumid NB / -40° up to +80° C
Material (mounting brackets)* - permitted temperature °C	igumid G / -40° up to +120° C
Flammability class (e-chain)*, igumid NB	VDE 0304 IIC UL94 V2
Flammability class (mounting brackets), igumid G*	VDE 0304 IIC UL94 HB

\*Available in igumid NB upon request, please consult igus® for delivery time

### Technical Data



Details of material properties  
► page 1.38



easy chain®  
Inner height: 9,4 mm

Phone +49- (0) 22 03-96 49-800  
Fax +49- (0) 22 03-96 49-222



► page 3.5



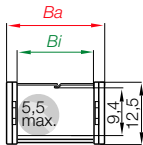

Series E045 - split crossbar along the outer radius

Part No.	$B_i$ [mm]	$B_a$ [mm]	$R$ [mm]	Bending radii	Weight [kg/m]
E045.10. <input type="text"/> .0*	10	16	<input type="text"/> 018 <input type="text"/> 028 <input type="text"/> 038	~ 0,09	
E045.16. <input type="text"/> .0	16	23	<input type="text"/> 018 <input type="text"/> 028 <input type="text"/> 038	~ 0,11	

**Ba:** pin dimension approx. 0,1 - 0,3 mm wider!

\*Crossbars do not overlap! Gap: E045.10. = 2 mm

Supplement Part No. with required radius. Example: E045.16.038.0

0 = standard color, other colors ▶ page 1.39 · Pitch = 13 mm/link - Links/m = 77

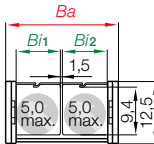

Series E045 - split crossbar along the outer radius with 2-chamber system

Part No.	$B_i$ [mm]	$B_a$ [mm]	$R$ [mm]	Bending radii	Weight [kg/m]
E045.2/7. <input type="text"/> .0*	7 / 7	23	<input type="text"/> 018 <input type="text"/> 028 <input type="text"/> 038	~ 0,13	
E045.2/9. <input type="text"/> .0*	9 / 9	27	<input type="text"/> 018 <input type="text"/> 028 <input type="text"/> 038	~ 0,14	

**Ba:** pin dimension approx. 0,1 - 0,3 mm wider!

\*Crossbars do not overlap! Gap: E045.2/7. = 2,25 mm, E045.2/9. = 2,25 mm

Supplement Part No. with required radius. Example: E045.2/9.038.0

0 = standard color, other colors ▶ page 1.39 · Pitch = 13 mm/link - Links/m = 77

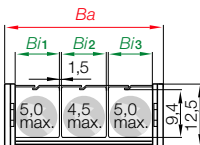

Series E045 - split crossbar along the outer radius with 3-chamber system

Part No.	$B_i$ [mm]	$B_a$ [mm]	$R$ [mm]	Bending radii	Weight [kg/m]
E045.3/9. <input type="text"/> .0*	9 / 9 / 9	37	<input type="text"/> 018 <input type="text"/> 028 <input type="text"/> 038	~ 0,17	

**Ba:** pin dimension approx. 0,1 - 0,3 mm wider!

\*Crossbars do not overlap! Gap: Spalt: E045.3/9. = 2,25 mm

Supplement Part No. with required radius. Example: E045.3/9.038.0

0 = standard color, other colors ▶ page 1.39 · Pitch = 13 mm/link - Links/m = 77

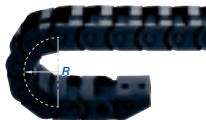

Part No. structure

E045. 16. 038.0

Color  
black  
Bending  
radius  
Width  
Series



Phone +49- (0) 22 03-96 49-800  
Fax +49- (0) 22 03-96 49-222

igus® GmbH  
51147 Cologne

Internet: www.igus.eu  
E-mail: info@igus.de

Series Z045 - split crossbar along the inner radius

Part No.	$B_i$ [mm]	$B_a$ [mm]	$R$ [mm]	Bending radii	Weight [kg/m]
Z045.16.□.0*	16	23	018	028 038	≈ 0,11

$B_a$ : pin dimension approx. 0,1 - 0,3 mm wider!

\*Crossbars do not overlap! Gap: Z045.16. = 2 mm

Supplement Part No. with required radius. Example: Z045.16.□.038.0

0 = standard color, other colors ▶ page 1.39 · Pitch = 13 mm/link - Links/m = 77

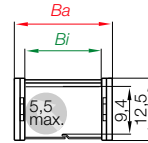

Series Z045 - split crossbar along the inner radius with 2-chamber system

Part No.	$B_i$ [mm]	$B_a$ [mm]	$R$ [mm]	Bending radii	Weight [kg/m]
Z045.2/7.□.0*	7 / 7	23	018	028 038	≈ 0,13

$B_a$ : pin dimension approx. 0,1 - 0,3 mm wider!

\*Crossbars do not overlap! Gap: Z045.2/7. = 2,25 mm

Supplement Part No. with required radius. Example: Z045.2/7.□.038.0

0 = standard color, other colors ▶ page 1.39 · Pitch = 13 mm/link - Links/m = 77

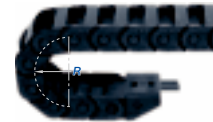
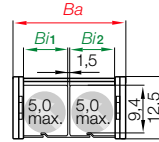

Part No. structure

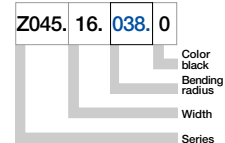

easy chain®  
Inner height: 9,4 mm

Phone +49- (0) 22 03-96 49-800  
Fax +49- (0) 22 03-96 49-222



▶ page 3.5

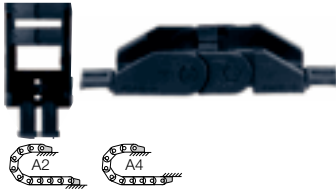

**Polymer, one-piece**

- One-piece mounting bracket
- Corrosion-resistant
- Available preassembled

Moving end with bore  
(outer link) 045...1

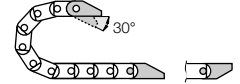

Possible installation conditions for assembled mounting brackets ▶ Order example "preassembled" below

045...2 E03...2Z Fixed end  
with pin (inner link)

**Dimensions and order configurations**

045...1

Moving end

045...2

Fixed end

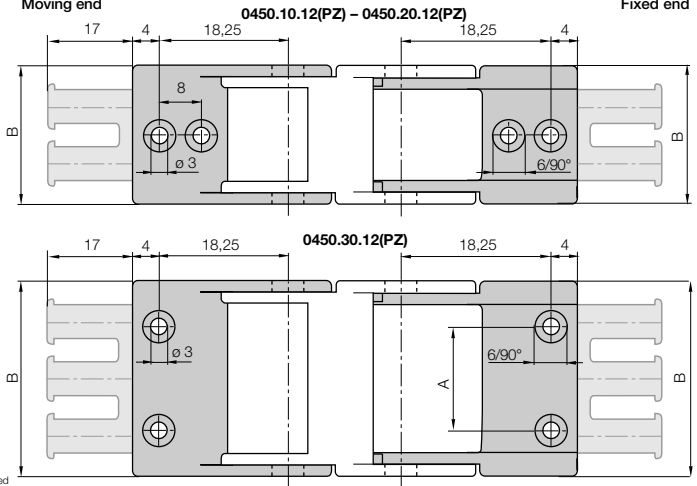

**Part No. structure**

0450. 10. 12 PZ A2

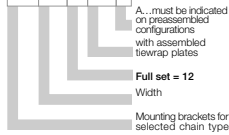

A... must be indicated on preassembled configurations with assembled tie-wrap plates

Full set = 12  
Width

Mounting brackets for selected chain type

Full set, for both ends:

0450. 10. 12 PZ +tie-wrap plate

Single-part order:

0450. 10. 1 PZ +tie-wrap plate

Mounting bracket with bore

0450. 10. 2 PZ +tie-wrap plate

Mounting bracket with pin

For e-chain*	Part No. full set with tie-wrap plate	Part No. full set without tie-wrap plate	Number of teeth	Dim. A [mm]	Dim. B [mm]
E045.10.	▶ 0450.10. 12 PZ	0450.10. 12	1	-	16
E/Z045.16.	▶ 0450.16. 12 PZ	0450.16. 12	2	-	22
E/Z045.2/7.	▶ 0450.16. 12 PZ	0450.16. 12	2	-	22
E045.2/9.	▶ 0450.20. 12 PZ	0450.20. 12	2	-	26
E045.3/9.	▶ 0450.30. 12 PZ	0450.30. 12	3	22	36

For the preassembled mode please add the index A2 or A4 e.g. 0450.20. 12 PZ A2

Mounting brackets with tie-wrap plate are available upon request. Time of delivery approx. 6-8 weeks after order. Mounting brackets without tie-wrap plate are available from stock.

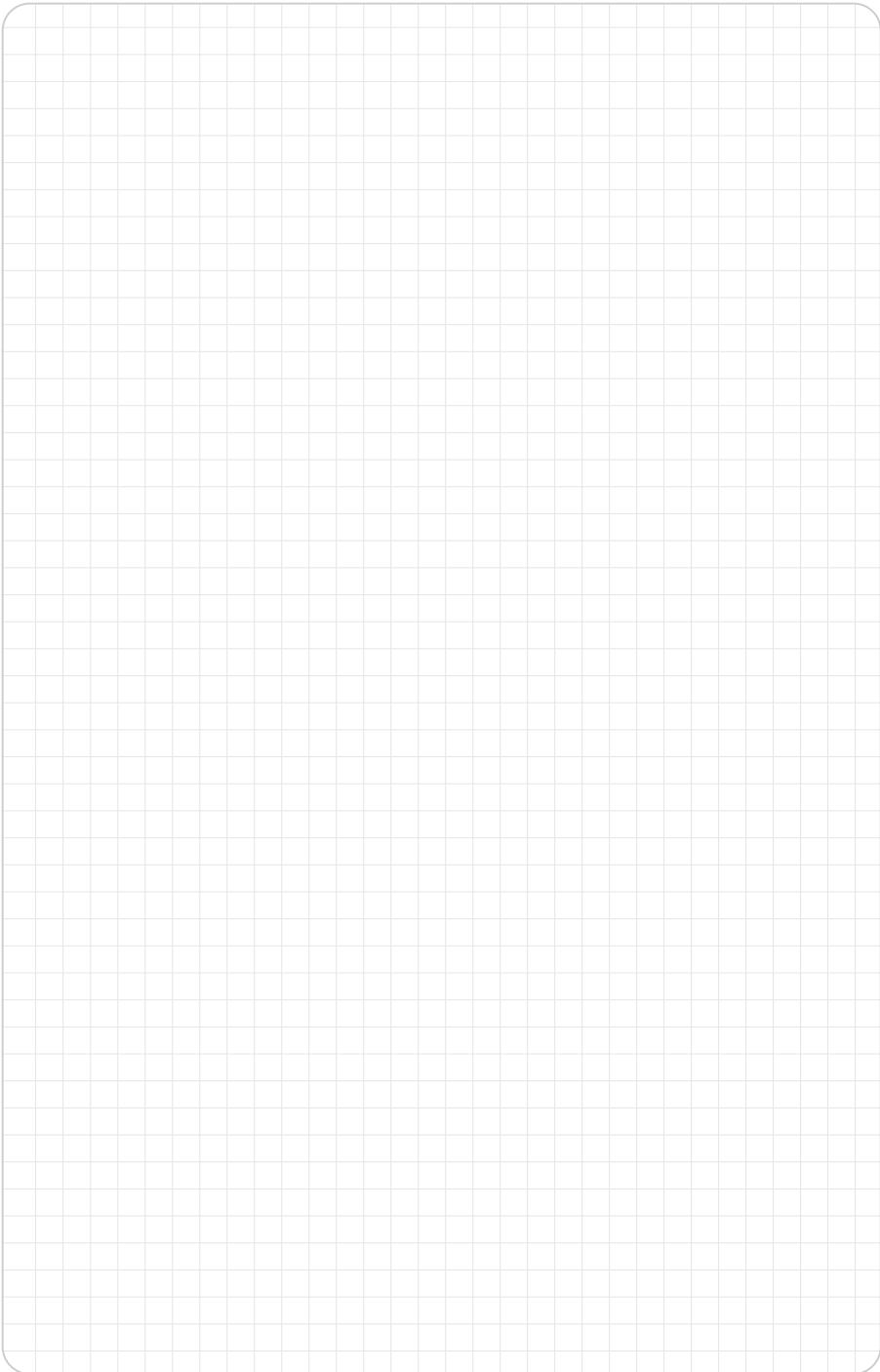

easy chain®  
Inner height: 9,4 mm

Phone +49- (0) 22 03-96 49-800  
Fax +49- (0) 22 03-96 49-222



● ● ● Price index

**IPA Qualification Certificate:**  
Air Cleanless Class ISO Class 2  
(at v = 1 m/s) upon request

**UL94-V2**  
classifications

**Torsional**  
motion possible

**Special equipment:**  
Electrically conductive ESD/ATEX  
version upon request

**42 dB(A)** - Value determined at the  
igus® test-lab: v = 1,0 m/s  
unsupported, Series E06.10.038.0

- ① Very easy to fill - ideal for harnessed cable assemblies
- ② Small pitch for low-noise, smooth operation
- ③ Limited torsion tolerance
- ④ Very light weight
- ⑤ The patented push-button principle holds the links together
- ⑥ Cable -friendly smooth interior
- ⑦ "E" Series features split crossbar along the outer radius
- ⑧ "Z" Series features split crossbar along the inner radius
- ⑨ Integrated strain relief option



Special solution -  
opening gap 3,5 mm  
Part No. E06.10.018S3



Just push the cables into the e-chain®  
with your thumb - and it's ready

**When to use the Series E06/Z06:**

- If filling is required without opening and closing lids
- If price is an issue
- If quiet operation is required

**When not to use it:**

- For applications with very high loads and long unsupported travel lengths
  - ▶ Series 06 E2 micro, page 5.36
- "Z" Series is unsuitable for gliding applications
  - ▶ Series 07 zipper, page 4.14



**Order example complete e-chain®**

Please indicate chain-lengths or number of links Example: 1 m or 50 links

1 m E06.10.038.0



e-chain®

1 set 060.10.12



Mounting bracket



### Unsupported length

$FL_G$  = with straight upper run

$FL_B$  = with permitted sag

Further information ► Design, page 1.12

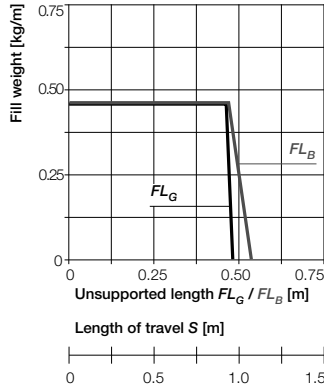
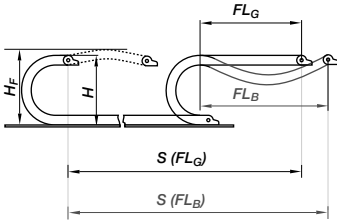

- $S$  = Length of travel
- $R$  = Bending radius
- $H$  = Nominal clearance height
- $H_F$  = Required clearance height
- $D$  = Overlength e-chain\*  
radius in final position
- $K = \pi \cdot R + \text{"safety"}$

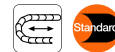
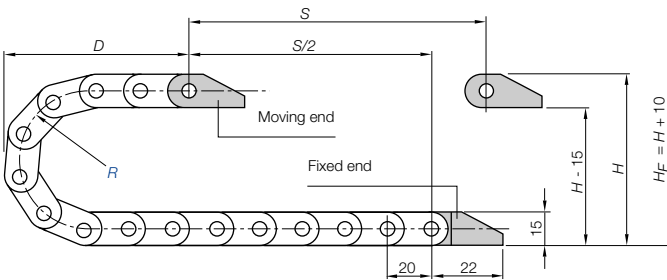

### Short travels - unsupported

Unsupported e-chains\* feature positive camber over short travels. This must be accounted for when specifying the clearance height  $H_F$ . Please consult igus® if space is particularly restricted.

Pitch = 20 mm/link    Links/m = 50 (1.000 mm)    Chain length =  $S/2 + K$

R	018	028	038
H	51	71	91
D	56	66	76
K	100	130	160

The required clearance height:  
 $H_F = H + 10$  mm  
(with 0,2 kg/m fill weight)



easy chain®  
Inner height: 10,7/10,5 mm

Phone +49- (0) 22 03-96 49-800  
Fax +49- (0) 22 03-96 49-222



Speed / acceleration $FL_G$	max. 20 [m/s] / max. 200 [m/s]
Speed / acceleration $FL_B$	max. 3 [m/s] / max. 6 [m/s]
Gliding speed / acceleration (maximum)	max. 3 [m/s] / max. 10 [m/s]
Material (e-chain)* - permitted temperature °C	igumid NB / -40° up to +80° C
Material (mounting brackets)* - permitted temperature °C	igumid G / -40° up to +120° C
Flammability class (e-chain)*, igumid NB	VDE 0304 IIC UL94 V2
Flammability class (mounting brackets), igumid G*	VDE 0304 IIC UL94 HB

\*Available in igumid NB upon request, please consult igus® for delivery time

### Technical Data



Details of material properties  
► page 1.38



► page 3.5

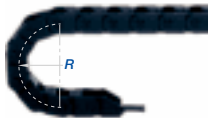
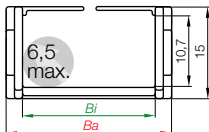

Part No. structure

E06. 10. 038. 0



## Series E06 - split crossbar along the outer radius

Part No.	Bi [mm]	Ba [mm]	R [mm]	Bending radii	Weight [kg/m]
E06.10. <input type="text"/> .0*	10	16,5	<input type="text"/> 018	<input type="text"/> 028 <input type="text"/> 038	≈ 0,14
E06.16. <input type="text"/> .0*	16	22,5	<input type="text"/> 018	<input type="text"/> 028 <input type="text"/> 038	≈ 0,16
E06.20. <input type="text"/> .0	20	26,5	<input type="text"/> 018	<input type="text"/> 028 <input type="text"/> 038	≈ 0,18

**Ba:** pin dimension approx. 0,2 - 0,4 mm wider!

\*Crossbars do not overlap! Gap: E06.10. = 5,5 mm, E06.16. = 5,5 mm

Supplement Part No. with required radius. Example: E06.10.  038  0

0 = standard color, other colors ▶ page 1.39 · Pitch = 20 mm/link - Links/m = 50

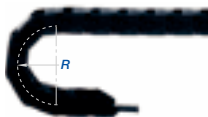
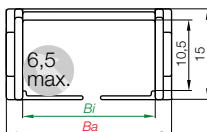

Part No. structure

Z06. 10. 038. 0



## Series Z06 - split crossbar along the inner radius

Part No.	Bi [mm]	Ba [mm]	R [mm]	Bending radii	Weight [kg/m]
Z06.10. <input type="text"/> .0*	10	16,5	<input type="text"/> 018	<input type="text"/> 028 <input type="text"/> 038	≈ 0,14
Z06.16. <input type="text"/> .0*	16	22,5	<input type="text"/> 018	<input type="text"/> 028 <input type="text"/> 038	≈ 0,16
Z06.20. <input type="text"/> .0	20	26,5	<input type="text"/> 018	<input type="text"/> 028 <input type="text"/> 038	≈ 0,18

**Ba:** pin dimension approx. 0,2 - 0,4 mm wider!

\*Crossbars do not overlap! Gap: Z06.10. = 5,5 mm, Z06.16. = 5,5 mm

Supplement Part No. with required radius. Example: Z06.10.  038  0

0 = standard color, other colors ▶ page 1.39 · Pitch = 20 mm/link - Links/m = 50





**Polymer, one-piece**

- One-piece mounting bracket
- Corrosion-resistant
- Available preassembled
- Inner and outer attachment possible
- Available with integrated strain relief tiwrap plates

Moving end with bore  
(outer link) 060...1(PZ)

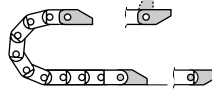

060...2(PZ) Fixed end  
with pin (inner link)

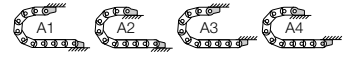

Possible installation conditions for assembled mounting brackets ▶ Order example "preassembled" below

060...1(PZ)

Moving end

060...2(PZ)

Fixed end

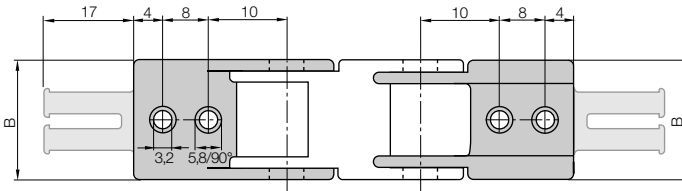

**Dimensions and order configurations**

Strain relief is possible on the moving end and/or the fixed end.

**Part No. structure**

060.10.12.PZ.A1

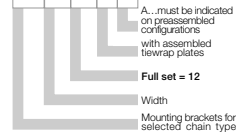

**Full set, for both ends:**

060.10.12.PZ +tiwrap plate

**Single-part order:**

060.10.1.PZ +tiwrap plate

Mounting bracket with bore

060.10.2.PZ +tiwrap plate

Mounting bracket with pin

For e-chain®	Part No. full set with tiwrap plate	Part No. full set without tiwrap plate	Number of teeth	Dim. B [mm]
E06-Z06.10. ▶	060.10.12.PZ	060.10.12	1	16,5
E06-Z06.16. ▶	060.16.12.PZ	060.16.12	2	22,5
E06-Z06.20. ▶	060.20.12.PZ	060.20.12	2	27

For the **preassembled** mode please add the index **A1...A4** e.g. 060.10.12.PZ**A1**



**Quicksnap** - the complete, detachable mounting unit.  
Part. No. 060.10.QS, 060.16.QS, 060.20.QS,  
060.40.QS available from stock



**Quickfix** - mounting bracket with dowel, available upon request

**Additional Features**

Phone +49- (0) 22 03-96 49-800  
Fax +49- (0) 22 03-96 49-222





● ● ● Price index



**IPA Qualification Certificate:**  
Air Cleanless Class ISO Class 2  
(at v = 1 m/s) upon request



**UL94-V2**  
classifications



**Torsional**  
motion possible



**Special equipment:**  
Electrically conductive ESD/ATEX  
version upon request



**Low-noise**  
due small pitch

- ① Very easy to fill - ideal for harnessed cable assemblies
- ② Small pitch for low-noise, smooth operation
- ③ Limited torsion tolerance
- ④ Very light weight
- ⑤ The patented push-button principle holds the links together
- ⑥ Cable-friendly interior
- ⑦ Split crossbar along inner and outer radius
- ⑧ Mounting bracket with integrated strain relief
- ⑨ 1-, 2-, 3- or 4-chamber system available



Just push the cables into the e-chain® with your thumb - and it's ready



**When to use the Series E065:**

- If filling is required without opening and closing lids
- If price is an issue
- If quiet operation is required



**When not to use it:**

- For applications with very high loads and long unsupported travel lengths
- ▶ Series 06 E2 micro, page 5.36

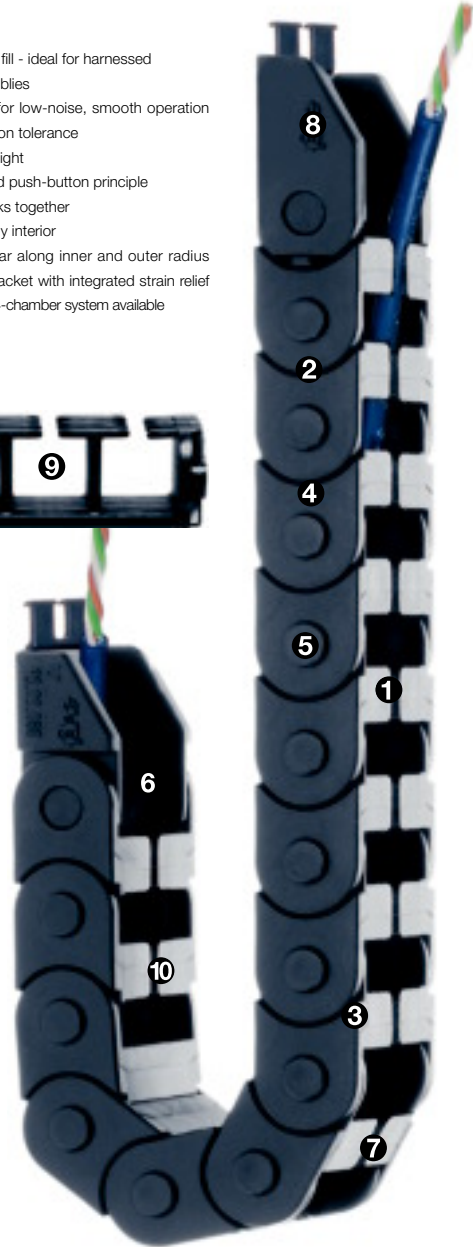

**Order example complete e-chain®**

Please indicate chain-lengths or number of links **Example: 1 m or 67 links**

1 m **E065.16.018.0**



**e-chain®**

1 set **0650.16.12PZ**



**Mounting bracket**



### Unsupported length

$FL_G$  = with straight upper run

$FL_B$  = with permitted sag

Further information ► Design, page 1.12

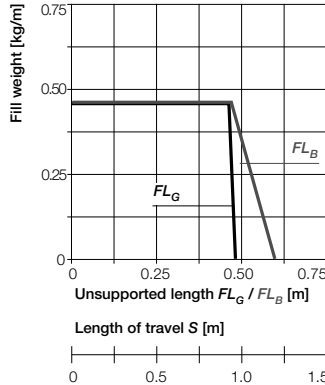
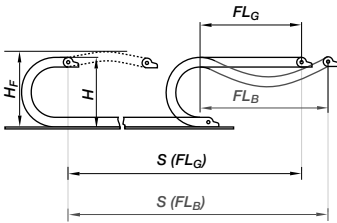

- $S$  = Length of travel
- $R$  = Bending radius
- $H$  = Nominal clearance height
- $H_F$  = Required clearance height
- $D$  = Overlength e-chain\*  
radius in final position
- $K = \pi \cdot R + \text{"safety"}$

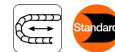
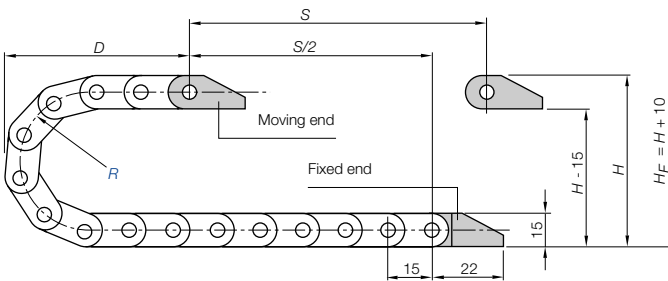

### Short travels - unsupported

Unsupported e-chains\* feature positive camber over short travels. This must be accounted for when specifying the clearance height  $H_F$ . Please consult igus® if space is particularly restricted.

Pitch = 15 mm/Glied Links/m = 67 (1.005 mm) Chain length =  $S/2 + K$

R	018	028	038
H	51	71	91
D	48	58	68
K	90	120	150

The required clearance height:  
 $H_F = H + 10$  mm  
(with 0,2 kg/m fill weight)

Speed / acceleration $FL_G$	max. 20 [m/s] / max. 200 [m/s <sup>2</sup> ]
Speed / acceleration $FL_B$	max. 3 [m/s] / max. 6 [m/s <sup>2</sup> ]
Gliding speed / acceleration (maximum)	max. 3 [m/s] / max. 10 [m/s <sup>2</sup> ]
Material (e-chain)* - permitted temperature °C	igumid NB / -40° up to +80° C
Material (mounting brackets)* - permitted temperature °C	igumid G / -40° up to +120° C
Flammability class (e-chain)*, igumid NB	VDE 0304 IIC UL94 V2
Flammability class (mounting brackets), igumid G*	VDE 0304 IIC UL94 HB

\*Available in igumid NB upon request, please consult igus® for delivery time

### Technical Data



Details of material properties  
► page 1.38

11,3 11,3

easy chain®  
Inner height: 11,3 mm

Phone +49- (0) 22 03-96 49-800  
Fax +49- (0) 22 03-96 49-222



► page 3.5

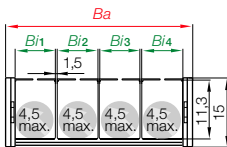
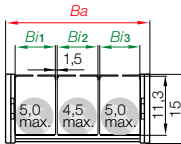
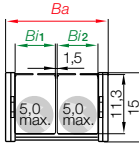
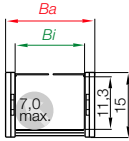

Part No. structure

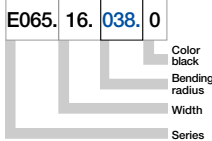

Series E065 - split crossbar along the outer radius

Part No.	Bi [mm]	Ba [mm]	R [mm] Bending radii	Weight [kg/m]
E065.16.□.0*	16	24,8	018 028 038	≈ 0,17

\*Crossbars do not overlap! Gap: E065.16. = 2,5 mm

Supplement Part No. with required radius. Example: E065.16.038.0

0 = standard color, other colors ▶ page 1.39 · Pitch = 15 mm/link - Links/m = 67

Series E065 - split crossbar along the outer radius with 2-chamber system

Part No.	Bi [mm]	Ba [mm]	R [mm] Bending radii	Weight [kg/m]
E065.2/9.□.0*	9 / 9	29,3	018 028 038	≈ 0,19

\*Crossbars do not overlap! Gap: E065.2/9. = 2,5 mm

Supplement Part No. with required radius. Example: E065.2/9.038.0

0 = standard color, other colors ▶ page 1.39 · Pitch = 15 mm/link - Links/m = 67

Series E065 - split crossbar along the outer radius with 3-chamber system

Part No.	Bi [mm]	Ba [mm]	R [mm] Bending radii	Weight [kg/m]
E065.3/9.□.0*	9 / 9 / 9	39,3	018 028 038	≈ 0,22

\*\*Crossbars do not overlap! Gap: E065.3/9. = 2,5 mm

Supplement Part No. with required radius. Example: E065.3/9.038.0

0 = standard color, other colors ▶ page 1.39 · Pitch = 15 mm/link - Links/m = 67

Series E065 - split crossbar along the outer radius with 4-chamber system

Part No.	Bi [mm]	Ba [mm]	R [mm] Bending radii	Weight [kg/m]
E065.4/9.□.0*	9 / 9 / 9 / 9	49,3	018 028 038	≈ 0,25

\*Crossbars do not overlap! Gap: E065.4/9. = 2,5 mm

Supplement Part No. with required radius. Example: E065.4/9.038.0

0 = standard color, other colors ▶ page 1.39 · Pitch = 15 mm/link - Links/m = 67

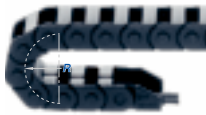
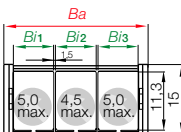

Part No. structure

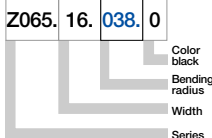

Series Z065 - split crossbar along the inner radius with 3-chamber system

Art. Nr.	Bi [mm]	Ba [mm]	R [mm] Biegeradien	Gewicht [kg/m]
Z065.3/9.□.0*	9 / 9 / 9	39,3	018 028 038	≈ 0,22

\*Crossbars do not overlap! Gap: Z065.3/9. = 2,5 mm

Supplement Part No. with required radius. Example: Z065.3/9.038.0

0 = standard color, other colors ▶ page 1.39 · Pitch = 15 mm/link - Links/m = 67





**Polymer, one-piece**

- One-piece mounting bracket
- Corrosion-resistant
- Available preassembled
- Inner and outer attachment possible
- Available with integrated strain relief tiwrap plates

Moving end with bore  
(outer link) 0650...1PZ

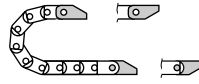

0650...2PZ Fixed end  
with pin (inner link)

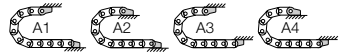

Possible installation conditions for assembled mounting brackets ▶ Order example "preassembled" below

0650...1PZ

Moving end

0650...2PZ

Fixed end

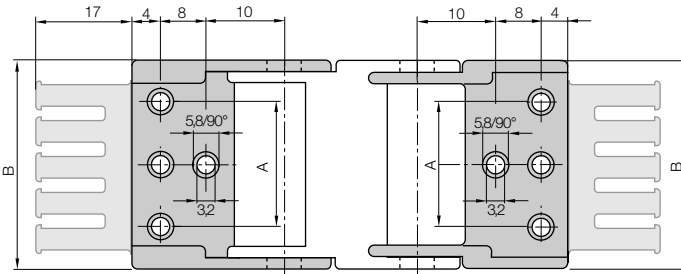

**Dimensions and order configurations**

Strain relief is possible on the moving end and/or the fixed end.

For e-chain®	Part No. full set with tiwrap plate	Part No. full set without tiwrap plate	Number of teeth	Dim. A [mm]	Dim. B [mm]
E065.16.	▶ 0650.16. 12 PZ	0650.16. 12	2	-	22,5
E065.2/9.	▶ 0650.2/9. 12 PZ	0650.2/9. 12	2	-	27
E065-Z065.3/9.	▶ 0650.3/9. 12 PZ	0650.3/9. 12	3	22	37
E065.4/9.	▶ 0650.4/9. 12 PZ	0650.4/9. 12	4	32	47

**Part No. structure**

0650. 16. 12 PZ A1

- A... must be indicated on preassembled configurations with assembled tiwrap plates
- Full set = 12
- Width
- Mounting brackets for selected chain type

Full set, for both ends:

0650. 16. 12 PZ +tiwrap plate

Single-part order:

0650. 16. 1 PZ +tiwrap plate

Mounting bracket with bore

0650. 16. 2 PZ +tiwrap plate

Mounting bracket with pin

For the preassembled mode please add the index A1 ... A4 e. g. 0650.16. 12 PZ A1



**Quicksnap** - the complete, detachable mounting unit, available upon request



**Quickfix** - mounting bracket with dowel, available upon request

**Additional Features**



● ● ● Price index



IPA Qualification Certificate:  
Air Cleanless Class ISO Class 2  
(at v = 1 m/s) upon request



UL94-V2  
classifications



Torsional  
motion possible



Special equipment:  
Electrically conductive ESD/ATEX  
version upon request



Low-noise  
due small pitch



Just pull out cable by hand  
- and it's ready



When to use the Series E08/Z08:

- If filling is required without opening and closing lids
- If price is an issue
- If quiet operation is required



When not to use it:

- For applications with very high loads and long unsupported travel lengths
  - ▶ Series 09 zipper, page 4.26
- "Z" Series is unsuitable for gliding applications
  - ▶ Series 09 zipper, page 4.26

- 1 Very easy to fill - ideal for harnessed cable assemblies
- 2 Small pitch for low-noise, smooth operation
- 3 Limited torsion tolerance
- 4 Light Weight
- 5 The patented push-button principle holds the links together
- 6 Cable-friendly interior
- 7 "E" Series features split crossbar along the outer radius
- 8 "Z" Series features split crossbar along the inner radius
- 9 Integrated strain relief option

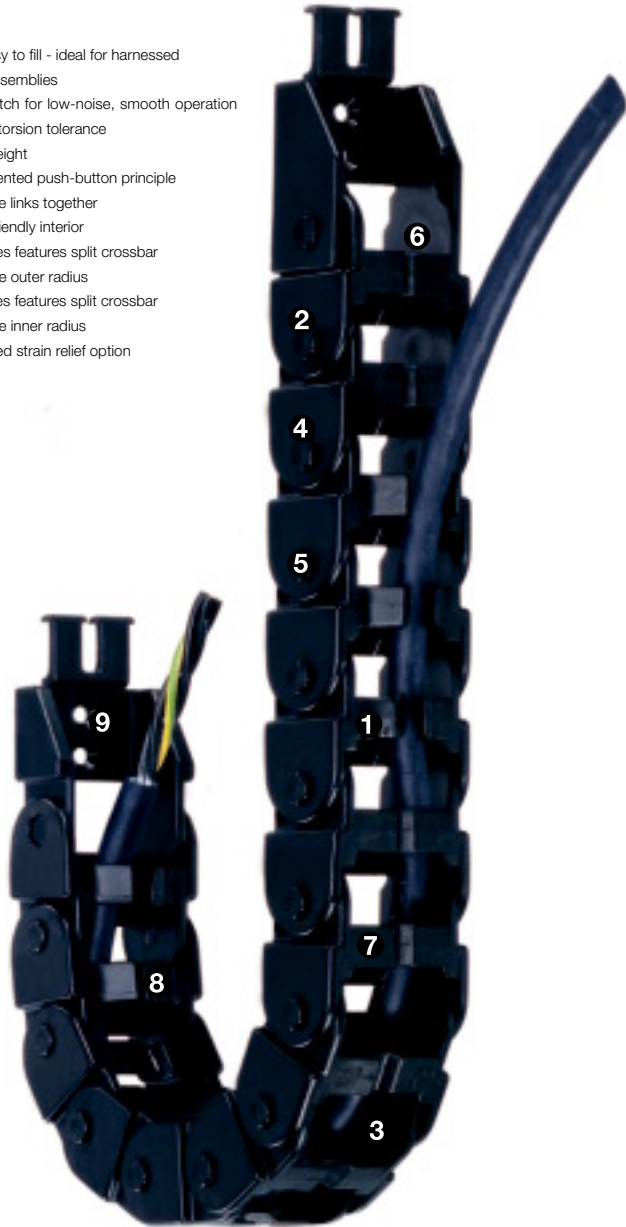

Order example complete e-chain®

Please indicate chain-lengths or number of links Example: 1 m or 50 links

1 m E08.30.038.0



e-chain®

1 set 080.30.12PZ



Mounting bracket



### Unsupported length

$FL_G$  = with straight upper run

$FL_B$  = with permitted sag

Further information ► **Design, page 1.12**

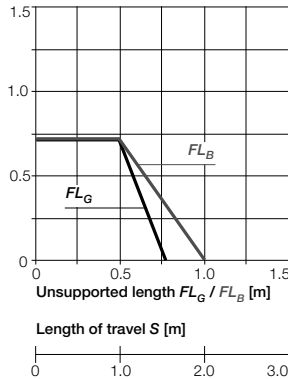
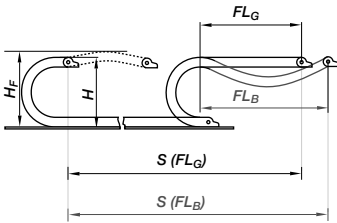

- $S$  = Length of travel
- $R$  = Bending radius
- $H$  = Nominal clearance height
- $H_F$  = Required clearance height
- $D$  = Overlength e-chain\* radius in final position
- $K = \pi \cdot R + \text{"safety"}$

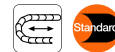
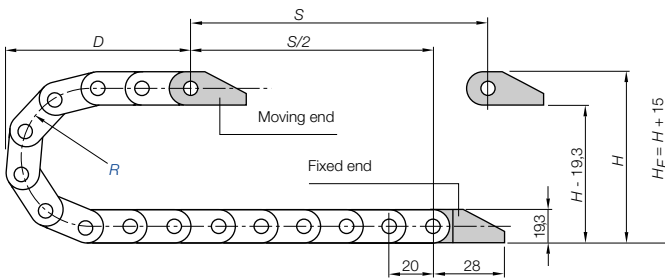

### Short travels - unsupported

Unsupported e-chains® feature positive camber over short travels. This must be accounted for when specifying the clearance height  $H_F$ . Please consult igus® if space is particularly restricted.

**Pitch = 20 mm/link    Links/m = 50 (1.000 mm)    Chain length =  $S/2 + K$**

R	025*	028	038	048
H	69	75	95	115
D	65	68	78	88
K	120	130	160	195

\*Radius 025 available upon request

The required

clearance height:

$H_F = H + 15$  mm

(with 0,3 kg/m fill weight)

Speed / acceleration $FL_G$	max. 20 [m/s] / max. 200 [m/s <sup>2</sup> ]
Speed / acceleration $FL_B$	max. 3 [m/s] / max. 6 [m/s <sup>2</sup> ]
Gliding speed / acceleration (maximum)	max. 3 [m/s] / max. 10 [m/s <sup>2</sup> ]
Material (e-chain*) - permitted temperature °C	igumid NB / -40° up to +80° C
Material (mounting brackets)* - permitted temperature °C	igumid G / -40° up to +120° C
Flammability class (e-chain*), igumid NB	VDE 0304 IIC UL94 V2
Flammability class (mounting brackets), igumid G*	VDE 0304 IIC UL94 HB

\*Available in igumid NB upon request, please consult igus® for delivery time

### Technical Data



Details of material properties

► page 1.38

14,6 14,7

easy chain®  
Inner height: 14,6/14,7 mm

Phone +49- (0) 22 03-96 49-800  
Fax +49- (0) 22 03-96 49-222



► page 3.5

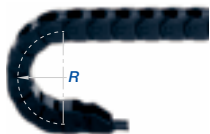
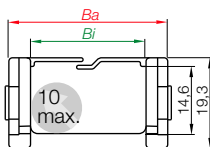

Part No. structure

E08. 30. 038. 0



## Series E08 - split crossbar along the outer radius

Part No.	Bi [mm]	Ba [mm]	R [mm]	Bending radii			Weight [kg/m]
E08.10. <input type="checkbox"/> .0*	10	18,2	025**	028	038	048	≈ 0,21
E08.16. <input type="checkbox"/> .0*	16	24,2	025**	028	038	048	≈ 0,24
E08.20. <input type="checkbox"/> .0	20	28,2	025**	028	038	048	≈ 0,25
E08.30. <input type="checkbox"/> .0	30	38,2	025**	028	038	048	≈ 0,28
E08.40. <input type="checkbox"/> .0	40	48,2	025**	028	038	048	≈ 0,31
E08.50. <input type="checkbox"/> .0	50	58,2	025**	028	038	048	≈ 0,37

**Ba:** pin dimension approx. 0,3 - 0,5 mm wider!

\*Crossbars do not overlap! Gap: E08.10. = 5,5 mm, E08.16. = 4 mm

\*\*Radius 025 available upon request

Supplement Part No. with required radius. Example: E08.30. 038.0

0 = standard color, other colors ▶ page 1.39 · Pitch = 20 mm/link - Links/m = 50

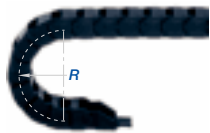
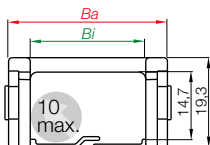

Part No. structure

Z08. 30. 038. 0



## Series Z08 - split crossbar along the inner radius

Part No.	Bi [mm]	Ba [mm]	R [mm]	Bending radii			Weight [kg/m]
Z08.10. <input type="checkbox"/> .0*	10	18,2	025**	028	038	048	≈ 0,21
Z08.16. <input type="checkbox"/> .0*	16	24,2	025**	028	038	048	≈ 0,24
Z08.20. <input type="checkbox"/> .0	20	28,2	025**	028	038	048	≈ 0,25
Z08.30. <input type="checkbox"/> .0	30	38,2	025**	028	038	048	≈ 0,28
Z08.40. <input type="checkbox"/> .0	40	48,2	025**	028	038	048	≈ 0,31
Z08.50. <input type="checkbox"/> .0	50	58,2	025**	028	038	048	≈ 0,37

**Ba:** pin dimension approx. 0,3 - 0,5 mm wider!

\*Crossbars do not overlap! Gap: Z08.10. = 5,5 mm, Z08.16. = 4 mm

\*\*Radius 025 available upon request

Supplement Part No. with required radius. Example: Z08.30. 038.0

0 = standard color, other colors ▶ page 1.39 · Pitch = 20 mm/link - Links/m = 50





**Polymer, one-piece**

- One-piece mounting bracket
- Corrosion-resistant
- Available preassembled
- Inner and outer attachment possible
- Available with integrated strain relief tiwrap plates

Moving end with bore  
(outer link) 080...1(PZ)

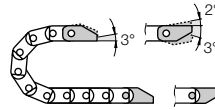

080...2(PZ) Fixed end  
with pin (inner link)

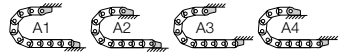

Possible installation conditions for assembled mounting brackets ▶ Order example "preassembled" below

080...1(PZ)

Moving end

080...2(PZ)

Fixed end

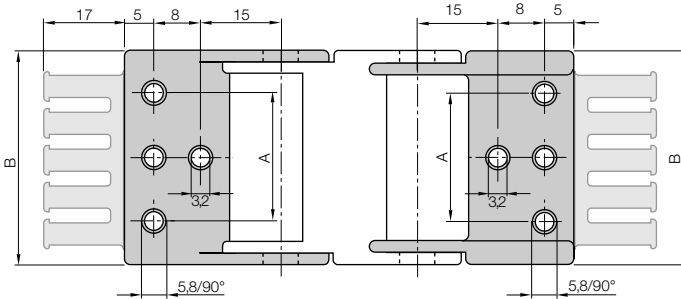

080.10.12 - 080.20.12: center bores only

080.30.12 - 080.50.12: all bores

For e-chain*	Part No. full set with tiwrap plate	Part No. full set without tiwrap plate	Number of teeth	Dim. A [mm]	Dim. B [mm]
E08-Z08.10. ▶	080.10.12 PZ	080.10.12	1	-	18,2
E08-Z08.16. ▶	080.16.12 PZ	080.16.12	2	-	24,2
E08-Z08.20. ▶	080.20.12 PZ	080.20.12	2	-	28,2
E08-Z08.30. ▶	080.30.12 PZ	080.30.12	3	22	38,2
E08-Z08.40. ▶	080.40.12 PZ	080.40.12	4	32	48,2
E08-Z08.50. ▶	080.50.12 PZ	080.50.12	5	42	58,2

For the preassembled mode please add the index **A1** ... **A4** e.g. 080.10.12 PZ **A1**

**Dimensions and order configurations**

Strain relief is possible on the moving end and/or the fixed end.

**Part No. structure**

080. 10. 12 PZ A1

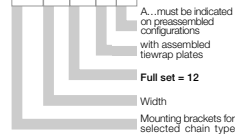

Full set, for both ends:

080. 10. 12 PZ +tiwrap plate

Single-part order:

080. 10. 1 PZ +tiwrap plate

Mounting bracket with bore

080. 10. 2 PZ +tiwrap plate

Mounting bracket with pin



**Quicksnap** - the complete, detachable mounting unit, available upon request



**Quickfix** - mounting bracket with dowel, available upon request

**Additional Features**

Phone +49- (0) 22 03-96 49-800  
Fax +49- (0) 22 03-96 49-222





● ● ● Price index



IPA Qualification Certificate:  
Air Cleanless Class ISO Class 2  
(at v = 1 m/s) upon request



UL94-V2  
classifications



Torsional  
motion possible



Special equipment:  
Electrically conductive ESD/ATEX  
version upon request



Low-noise  
due small pitch



Just push the cables into the e-chain®  
with your thumb - and it's ready



When to use the Series E14/Z14:

- If filling is required without opening and closing lids
- If price is an issue
- If quiet operation is required



When not to use it:

- For applications with very high loads and long unsupported travel lengths
  - ▶ Series B15 E2 mini, page 5.112
- "Z" Series is unsuitable for gliding applications
  - ▶ Series B15 E2 mini, page 5.112

- 1 Limited torsion tolerance
- 2 Very easy to fill - ideal for harnessed cable assemblies
- 3 The patented push-button principle holds the links together
- 4 Small pitch for low-noise, smooth operation
- 5 Cable-friendly interior
- 6 "E" Series features split crossbar along the outer radius
- 7 "Z" Series features split crossbar along the inner radius
- 8 Integrated strain relief option

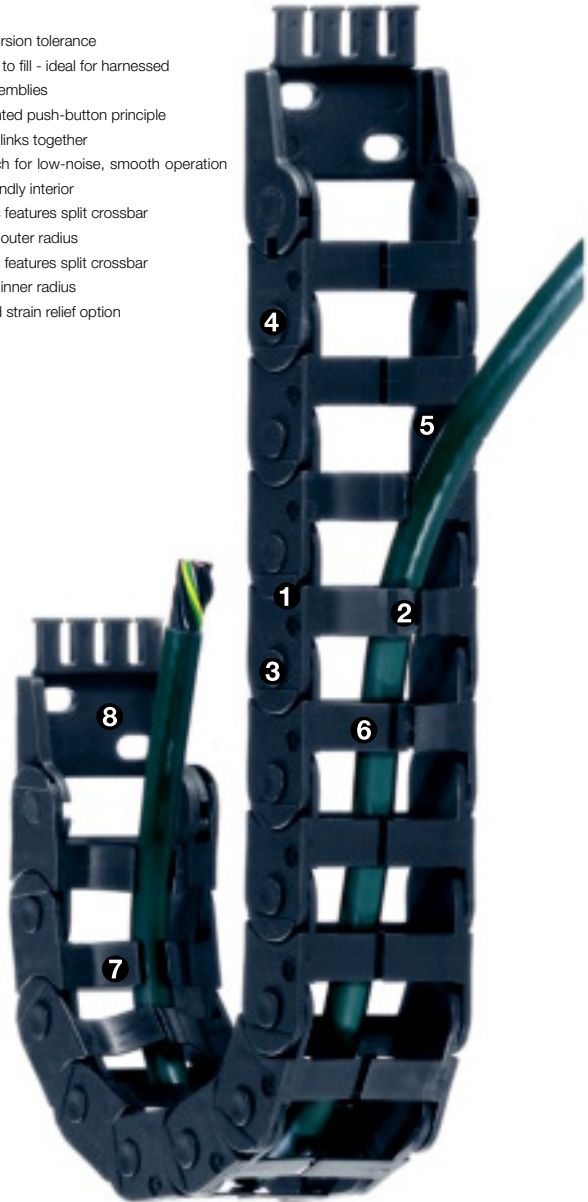

Order example complete e-chain®

Please indicate chain-lengths or number of links Example: 1 m or 33 links

1 m E14.3.038.0



e-chain®

1 set 114.3.12PZ



Mounting bracket



### Unsupported length

$FL_G$  = with straight upper run

$FL_B$  = with permitted sag

Further information ► **Design, page 1.12**

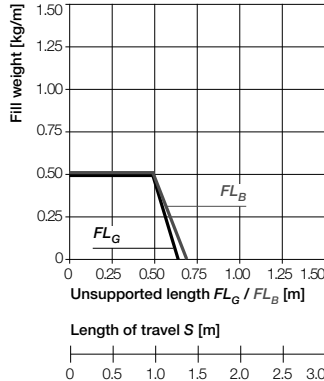
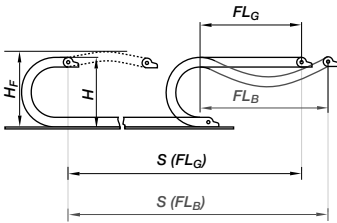

- $S$  = Length of travel
- $R$  = Bending radius
- $H$  = Nominal clearance height
- $H_F$  = Required clearance height
- $D$  = Overlength e-chain\*  
radius in final position
- $K = \pi \cdot R + \text{"safety"}$

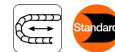
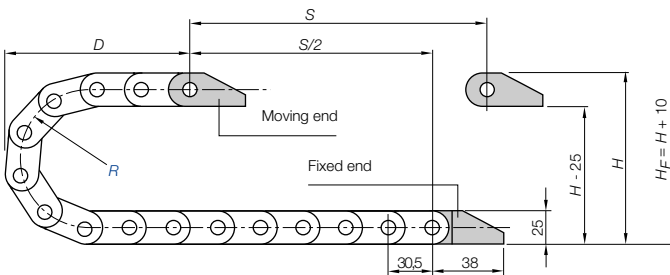

### Short travels - unsupported

Unsupported e-chains\* feature positive camber over short travels. This must be accounted for when specifying the clearance height  $H_F$ . Please consult igus® if space is particularly restricted.

**Pitch = 30,5 mm/link Links/m = 33 (1.006,5 mm) Chain length =  $S/2 + K$**

R	028	038	048	075	100	125
H	81	101	121	175	225	275
D	86	96	106	133	158	183
K	150	185	215	300	380	455

The required clearance height:  
 $H_F = H + 10$  mm  
(with 0,2 kg/m fill weight)

Speed / acceleration $FL_G$	max. 20 [m/s] / max. 200 [m/s <sup>2</sup> ]
Speed / acceleration $FL_B$	max. 3 [m/s] / max. 6 [m/s <sup>2</sup> ]
Gliding speed / acceleration (maximum)	max. 3 [m/s] / max. 10 [m/s <sup>2</sup> ]
Material (e-chain)* - permitted temperature °C	igumid NB / -40° up to +80° C
Material (mounting brackets)* - permitted temperature °C	igumid G / -40° up to +120° C
Flammability class (e-chain)*, igumid NB	VDE 0304 IIC UL94 V2
Flammability class (mounting brackets), igumid G*	VDE 0304 IIC UL94 HB

\*Available in igumid NB upon request, please consult igus® for delivery time

### Technical Data



Details of material properties  
► page 1.38



easy chain®  
Inner height: 19 mm

Phone +49- (0) 22 03-96 49-800  
Fax +49- (0) 22 03-96 49-222



► page 3.5

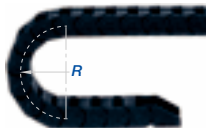
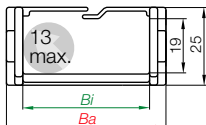

Part No. structure

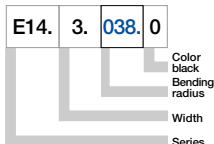

Series E14 - split crossbar along the outer radius

Part No.	Bi [mm]	Ba [mm]	R [mm]	Bending radii						Weight [kg/m]
E14.1. <input type="text"/> .0	15	27	<input type="text"/> 028	<input type="text"/> 038	<input type="text"/> 048	<input type="text"/> 075	<input type="text"/> 100	<input type="text"/> 125	≈ 0,31	
E14.2. <input type="text"/> .0	25	37	<input type="text"/> 028	<input type="text"/> 038	<input type="text"/> 048	<input type="text"/> 075	<input type="text"/> 100	<input type="text"/> 125	≈ 0,32	
E14.3. <input type="text"/> .0	38	50	<input type="text"/> 028	<input type="text"/> 038	<input type="text"/> 048	<input type="text"/> 075	<input type="text"/> 100	<input type="text"/> 125	≈ 0,40	
E14.4. <input type="text"/> .0	50	62	<input type="text"/> 028	<input type="text"/> 038	<input type="text"/> 048	<input type="text"/> 075	<input type="text"/> 100	<input type="text"/> 125	≈ 0,44	

Ba: pin dimension approx. 0,3 - 0,5 mm wider!

Supplement Part No. with required radius. Example: E14.3.038.0

0 = standard color, other colors ▶ page 1.39 · Pitch = 30,5 mm/link - Links/m = 33

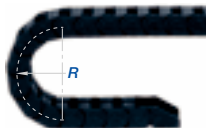
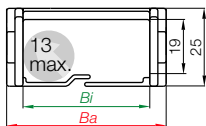

Part No. structure

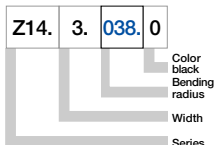

Series Z14 - split crossbar along the inner radius

Part No.	Bi [mm]	Ba [mm]	R [mm]	Bending radii						Weight [kg/m]
Z14.1. <input type="text"/> .0	15	27	<input type="text"/> 028	<input type="text"/> 038	<input type="text"/> 048	<input type="text"/> 075	<input type="text"/> 100	<input type="text"/> 125	≈ 0,31	
Z14.2. <input type="text"/> .0	25	37	<input type="text"/> 028	<input type="text"/> 038	<input type="text"/> 048	<input type="text"/> 075	<input type="text"/> 100	<input type="text"/> 125	≈ 0,32	
Z14.3. <input type="text"/> .0	38	50	<input type="text"/> 028	<input type="text"/> 038	<input type="text"/> 048	<input type="text"/> 075	<input type="text"/> 100	<input type="text"/> 125	≈ 0,40	
Z14.4. <input type="text"/> .0	50	62	<input type="text"/> 028	<input type="text"/> 038	<input type="text"/> 048	<input type="text"/> 075	<input type="text"/> 100	<input type="text"/> 125	≈ 0,44	

Ba: pin dimension approx. 0,3 - 0,5 mm wider!

Supplement Part No. with required radius. Example: Z14.3.038.0

0 = standard color, other colors ▶ page 1.39 · Pitch = 30,5 mm/link - Links/m = 33





**Polymer, one-piece**

- One-piece mounting bracket
- Corrosion-resistant
- Available preassembled
- Inner and outer attachment possible
- Available with integrated strain relief tiwrap plates

Moving end with bore  
(outer link) 114...1P(Z)

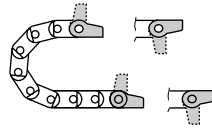

114...2P(Z) Fixed end  
with pin (inner link)

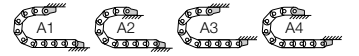

Possible installation conditions for assembled mounting brackets ▶ Order example "preassembled" below

114...1P(Z)

Moving end

114...2P(Z)

Fixed end

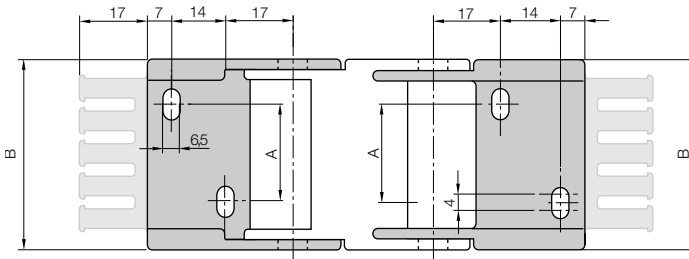

**Dimensions and order configurations**

Strain relief is possible on the moving end and/or the fixed end.

**Part No. structure**

114. 1. 12 PZ A1

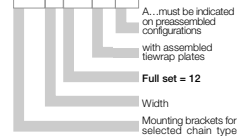

Full set, for both ends:

114. 1. 12 PZ +tiwrap plate

Single-part order:

114. 1. 1 PZ +tiwrap plate

Mounting bracket with bore

114. 1. 2 PZ +tiwrap plate

Mounting bracket with pin

For e-chain*	Part No. full set with tiwrap plate	Part No. full set without tiwrap plate	Number of teeth	Dim. A [mm]	Dim. B [mm]
E14-Z14.1. ▶	114. 1. 12PZ	114. 1. 12P	2	-	26,3
E14-Z14.2. ▶	114. 2. 12PZ	114. 2. 12P	3	10	36,3
E14-Z14.3. ▶	114. 3. 12PZ	114. 3. 12P	4	23	49,3
E14-Z14.4. ▶	114. 4. 12PZ	114. 4. 12P	5	35	62,3

Please add the Part No. with the requested index - e.g. 114. 1. 12

For the preassembled mode please add the index A1 ... A4 e.g. 114. 1. 12PZ A1



**Quicksnap** - the complete, detachable mounting unit, available upon request



**Quickfix** - mounting bracket with dowel, available upon request

**Additional Features**



● ● ● Price index



IPA Qualification Certificate:  
Air Cleanless Class ISO Class 2  
(at v = 1 m/s) upon request



UL94-V2  
classifications



Torsional  
motion possible



Special equipment:  
Electrically conductive ESD/ATEX  
version upon request

- ① Large pins for long service life
- ② Limited torsion tolerance
- ③ "E" Series features split crossbar along the outer radius
- ④ "Z" Series features split crossbar along the inner radius
- ⑤ Cable-friendly interior
- ⑥ Mounting bracket with integrated strain relief
- ⑦ Dirt-repellent exterior
- ⑧ Very easy to fill - cables only have to be pushed in
- ⑨ The patented push-button principle holds the links together
- ⑩ 1- or 2-chamber system available

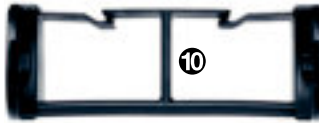

Just push the cables into the e-chain®  
with your thumb - and it's ready



When to use the Series E200/Z200:

- If filling is required without opening and closing lids
- If price is an issue
- If quiet operation is required



When not to use it:

- For applications with very high loads and long unsupported travel lengths
  - ▶ Series 2400/2450/2480/2500 E2/000, page 5.160
- If single-extrusion crossbars are required
  - ▶ Series 2400/2450/2480/2500 E2/000, page 5.160

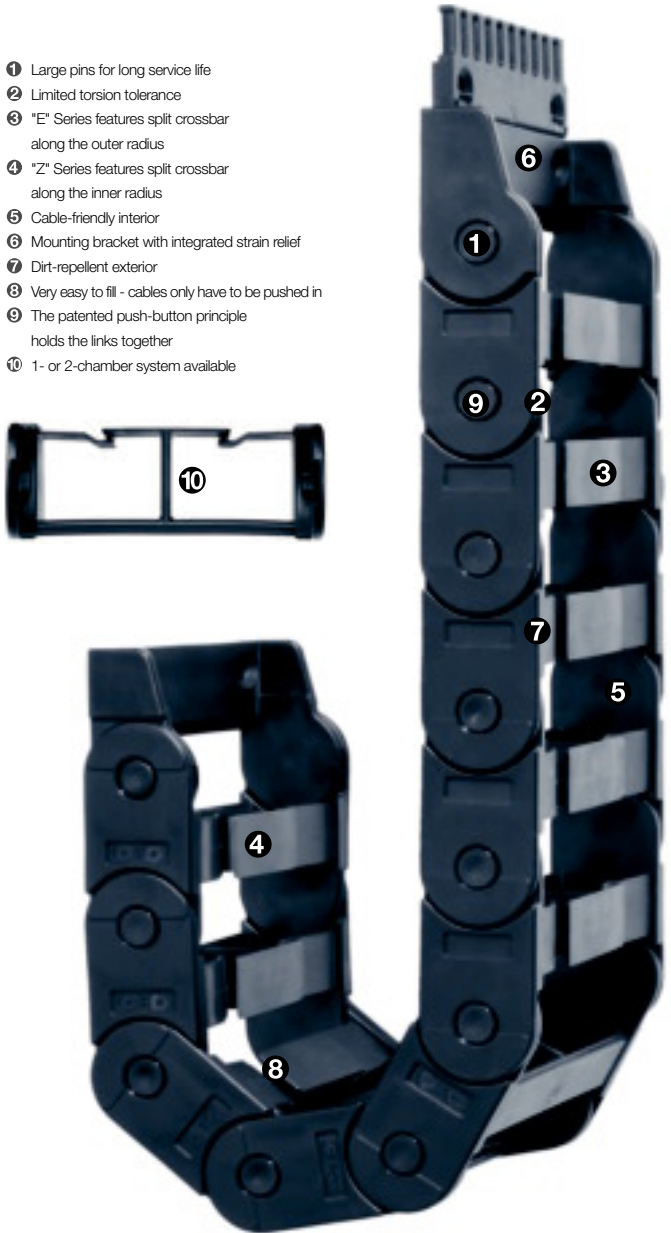

Order example complete e-chain®

Please indicate chain-lengths or number of links Example: 1 m or 22 links

1 m E200.05.100.0



e-chain®

1 set 2050.34PZB



Mounting bracket



### Unsupported length

$FL_G$  = with straight upper run

$FL_B$  = with permitted sag

Further information ► Design, page 1.12

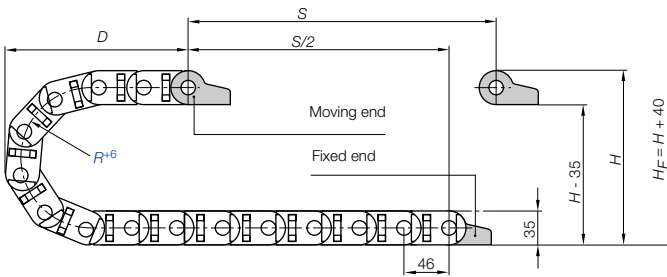
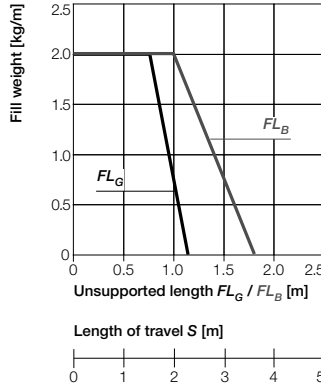
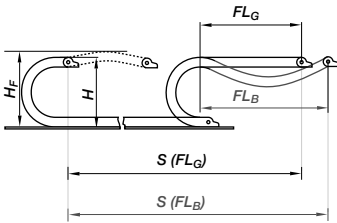

Pitch = 46 mm/link    Links/m = 22 (1.012 mm)    Chain length =  $S/2 + K$

R	055	075	100	150	200
H +4	145	185	235	335	435
D	142	162	187	237	287
K	265	330	410	565	725

- S = Length of travel
- R = Bending radius
- H = Nominal clearance height
- $H_F$  = Required clearance height
- D = Overlength e-chain\*  
radius in final position
- $K = \pi \cdot R + \text{"safety"}$

#### Other installation methods

- Vertical, hanging  $\leq 10$  m
- Vertical, standing  $\leq 1,5$  m
- Side mounted, un supp.  $\leq 0,5$  m
- Rotary requires further calculation
- Unsupported length of upper run = upon request

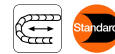

### Short travels - unsupported

Unsupported e-chains\* feature positive camber over short travels. This must be accounted for when specifying the clearance height  $H_F$ . Please consult igus\* if space is particularly restricted.

The required clearance height:  
 $H_F = H + 40$  mm  
(with 2,5 kg/m fill weight)

Speed / acceleration $FL_G$	max. 20 [m/s] / max. 200 [m/s <sup>2</sup> ]
Speed / acceleration $FL_B$	max. 3 [m/s] / max. 6 [m/s <sup>2</sup> ]
Gliding speed / acceleration (maximum)	max. 3 [m/s] / max. 10 [m/s <sup>2</sup> ]
Material (e-chain)* - permitted temperature °C	igumid NB / -40° up to +80° C
Material (mounting brackets)* - permitted temperature °C	igumid G / -40° up to +120° C
Flammability class (e-chain)*, igumid NB	VDE 0304 IIC UL94 V2
Flammability class (mounting brackets), igumid G*	VDE 0304 IIC UL94 HB

\*Available in igumid NB upon request, please consult igus\* for delivery time

### Technical Data



Details of material properties  
► page 1.38

24,3

easy chain®  
Inner height: 24,3 mm

Phone +49- (0) 22 03-96 49-800  
Fax +49- (0) 22 03-96 49-222



► page 3.5

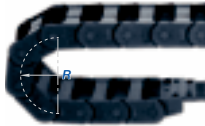
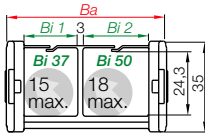
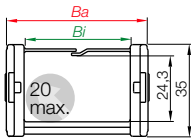

Part No. structure

E200. 05. 100. 0



## Series E200 - split crossbar along the outer radius

Part No.	Bi [mm]	Ba [mm]	R [mm]	Bending radii					Weight [kg/m]
E200.05. <input type="text"/> .0	57	74,4	055	075	100	150	200	~ 0,70	

Ba: pin dimension approx. 0,1 - 0,3 mm wider!

Supplement Part No. with required radius. Example: E200.05.  .0

0 = standard color, other colors ► page 1.39 · Pitch = 46 mm/link - Links/m = 22

## Series E200 - split crossbar along the outer radius with 2-chamber system

Part No.	Bi [mm]	Ba [mm]	R [mm]	Bending radii					Weight [kg/m]
E200.2/35. <input type="text"/> .0	37	94,4	055	075	100	150	200	~ 0,79	
E200.2/50. <input type="text"/> .0	50	120,4	055	075	100	150	200	~ 0,82	

Ba: pin dimension approx. 0,1 - 0,3 mm wider!

Supplement Part No. with required radius. Example: E200.2/50.  .0

0 = standard color, other colors ► page 1.39 · Pitch = 46 mm/link - Links/m = 22

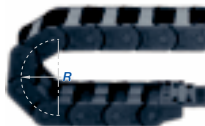
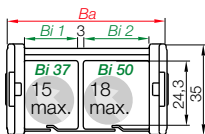
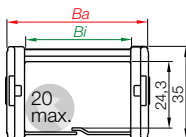

Part No. structure

Z200. 05. 100. 0



## Series Z200 - split crossbar along the inner radius

Part No.	Bi [mm]	Ba [mm]	R [mm]	Bending radii					Weight [kg/m]
Z200.05. <input type="text"/> .0	57	74,4	055	075	100	150	200	~ 0,70	

Ba: pin dimension approx. 0,1 - 0,3 mm wider!

Supplement Part No. with required radius. Example: Z200.05.  .0

0 = standard color, other colors ► page 1.39 · Pitch = 46 mm/link - Links/m = 22

## Series Z200 - split crossbar along the inner radius with 2-chamber system

Part No.	Bi [mm]	Ba [mm]	R [mm]	Bending radii					Weight [kg/m]
Z200.2/35. <input type="text"/> .0	37	94,4	055	075	100	150	200	~ 0,79	
Z200.2/50. <input type="text"/> .0	50	120,4	055	075	100	150	200	~ 0,82	

Ba: pin dimension approx. 0,1 - 0,3 mm wider!

Supplement Part No. with required radius. Example: Z200.2/50.  .0

0 = standard color, other colors ► page 1.39 · Pitch = 46 mm/link - Links/m = 22



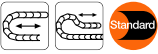

### The Standard - option polymer - pivoting

- Recommended for unsupported and gliding applications
- Well suited for tight installation conditions
- Strain relief with detachable tiwrap plates
- Variable traverse angle for flexible assembly
- The twistability of the e-chain® and the option to assemble the mounting brackets on the fixed end and/or the moving end, enable various installation options

Moving end with bore (outer link) 2...3PZ(B)

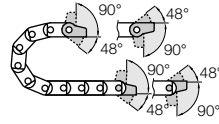

2...4PZ(B) Fixed end with pin (inner link)

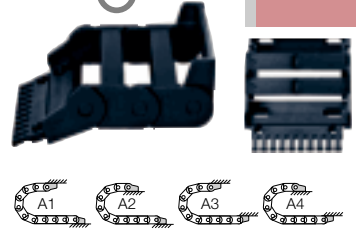

Possible installation conditions for assembled mounting brackets ► Order example "preassembled" below

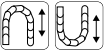

### Option polymer - locking

- Recommended for unsupported and gliding applications
- At very high speed and/or acceleration
- If space is limited for height (the  $H_f$  measurement)
- The twistability of the e-chain® and the option to assemble the mounting brackets on the fixed end and/or the moving end, enable various installation options

Moving end with bore (outer link) 2...1PZ(B)

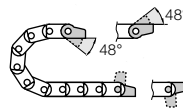

2...2PZ(B) Fixed end with pin (inner link)

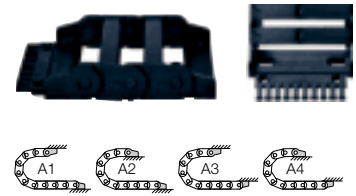

Possible installation conditions for assembled mounting brackets ► Order example "preassembled" below

2...3PZ(B) Standard! (pivoting)

2...1PZ(B) (locking)

Moving end

Standard! (pivoting) 2...4PZ(B)

(locking) 2...2PZ(B)

Fixed end

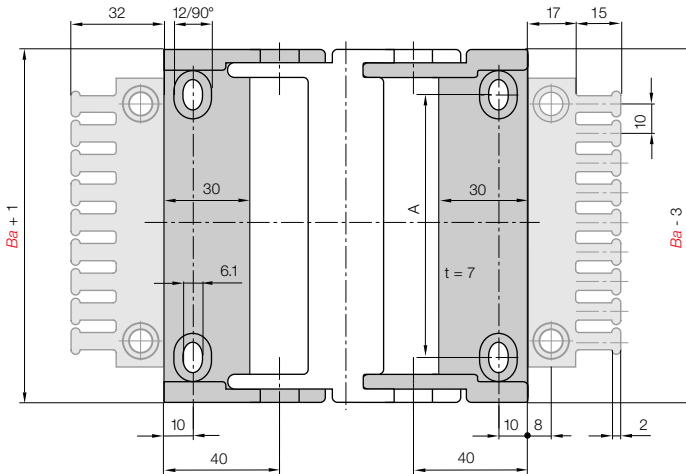

For e-chain®	Part No. full set with tiwrap plate	Part No. tiwrap plate + 10 cable tiwraps	Part No. full set without tiwrap plate	Number of teeth	Dim. A [mm]
E200-Z200.05	2050. [ ] PZB	2050. [ ] PZBK1	2050. [ ] PZ	6	44
E200-Z200.2/35	2070. [ ] PZB	2070. [ ] PZBK1	2070. [ ] PZ	8	64
E200-Z200.2/50	2100. [ ] PZB	2100. [ ] PZBK1	2100. [ ] PZ	10	90

Please add the Part No. with the requested index - 34 for the pivoting configuration

e.g. 2050. [34] PZB or 12 for the locking configuration e.g. 2050. [12] PZB

For the preassembled mode please add the index [A1]...[A4] e.g. 2050. [34] PZB [A1]

### Dimensions and order configurations

Strain relief is possible on the moving end and/or the fixed end.

#### Part No. structure (pivoting)

2050.	34	PZB	A1
-------	----	-----	----



A... must be indicated on preassembled configurations with assembled tiwrap plates  
Full set pivoting = 34  
Mounting brackets for selected chain type

#### Full set, for both ends:

2050. [34] PZB +tiwrap plate

#### Single-part order:

2050. [3] PZB +tiwrap plate

Mounting bracket with bore

2050. [4] PZB +tiwrap plate

Mounting bracket with pin

#### Part No. structure (locking)

2050.	12	PZB	A1
-------	----	-----	----



A... must be indicated on preassembled configurations with assembled tiwrap plates  
Full set locking = 12  
Mounting brackets for selected chain type

#### Full set, for both ends:

2050. [12] PZB +tiwrap plate

#### Single-part order:

2050. [1] PZB +tiwrap plate

Mounting bracket with bore

2050. [2] PZB +tiwrap plate

Mounting bracket with pin







### Strain relief for polymer mounting brackets (pivoting or locking)

The strain relief tiewrap plates can be directly snapped onto the mounting bracket. After bolting the mounting brackets to the machine, the strain relief tiewrap plates are also firmly connected to the base. They do not need to be bolted on separately. Cable tiewraps secure the tiewrap plate "teeth" and the cable to provide proper strain relief and save time. **Details ► chapter 10**

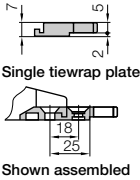

### Tiewrap plate as individual part

As an individual component screwed on or can be plugged into the mounting brackets. **Details ► chapter 10**

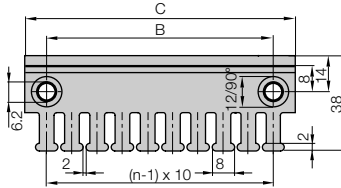

Tiewrap plate	No. of teeth <i>n</i>	Dim. C [mm]	Dim. B [mm]
2020.ZB	3	30	15
2030.ZB	4	40	20
2040.ZB	5	50	30
2050.ZB	6	60	40
2070.ZB	8	80	60
2090.ZB =			
(2030.ZB + 2040.ZB)	9	90	-
2100.ZB	10	100	80
2125.ZB =			
(2050.ZB + 2050.ZB)	12	120	-



### Cable tiewraps as individual part

Cable tiewraps 100 pieces/bag	Width x length	Max. Ø	Tensile strength
CFB.001	4,8 x 150 mm	36 mm	222 N



### "Double" strain relief

If an e-chain® is harnessed with a very large number of cables, strain relief may be necessary at two levels. Our 2050.Z strain relief system was developed for this purpose. It can be placed in any position along the e-chain®. As required, the 2050.Z strain relief system is simply clamped onto the crossbar of the chain link. No additional installation elements are needed. **Details ► chapter 10**

Part No.	Width strain relief [mm]	No. of teeth
2050.Z	60	6



Other strain relief elements - optional ► chapter 10

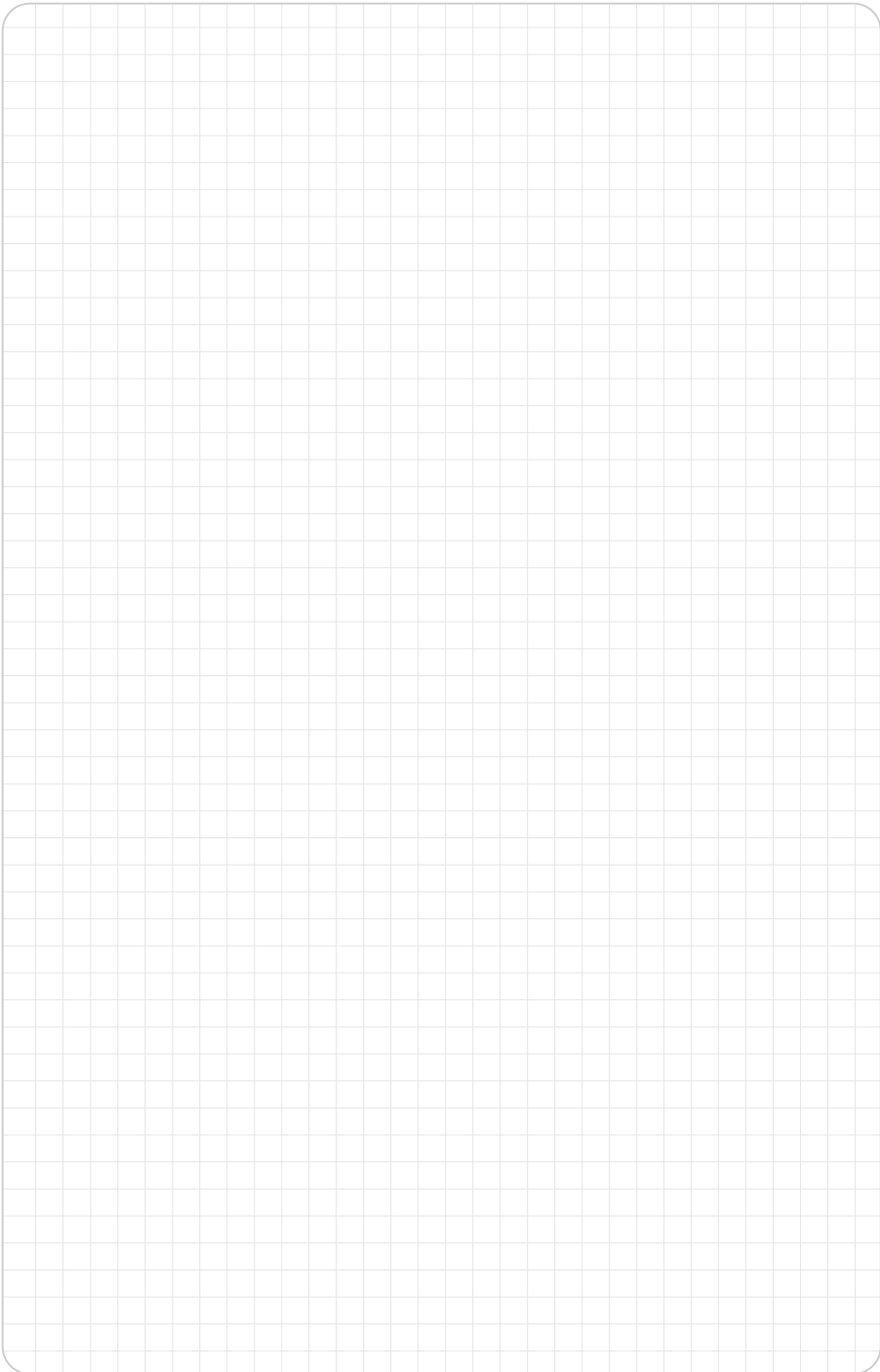

easy chain®  
Inner height: 24,3 mm

Phone +49- (0) 22 03-96 49-800  
Fax +49- (0) 22 03-96 49-222



▶ chapter 10



▶ page 3.5



Price index



IPA Qualification Certificate:  
Air Cleanless Class ISO Class 2  
(at v = 1 m/s) upon request



UL94-V2  
classifications



Torsional  
motion possible



Special equipment:  
Electrically conductive ESD/ATEX  
version upon request



Low-noise  
due small pitch



Just push the cables into the e-chain®  
with your thumb - and it's ready



When to use the Series E16/Z16:

- If filling is required without opening and closing lids
- If price is an issue
- If quiet operation is required



When not to use it:

- For applications with very high loads and long unsupported travel lengths
  - Series 2600/2650/2680/2700 E2/000, page 5.182
- If an e-chain® is needed with a high locking crossbar
  - Series 2600/2650/2680/2700 E2/000, page 5.182

- ① Limited torsion tolerance
- ② Small pitch for low-noise, smooth operation
- ③ Very easy to fill - ideal for harnessed cable assemblies
- ④ Cable-friendly interior
- ⑤ "E" Series features split crossbar along the outer radius
- ⑥ "Z" Series features split crossbar along the inner radius
- ⑦ Mounting brackets with integrated strain relief
- ⑧ The patented push-button principle holds the links together



Special solution -  
opening gap  
Part No. E16.2.100N3



Special solution -  
opening gap  
Part No. Z16.2.075N3



Order example complete e-chain®

Please indicate chain-lengths or number of links Example: 1 m or 33 links

1 m E16.3.060.0



e-chain®

1 set 117.3.12PZ



Mounting bracket



### Unsupported length

$FL_G$  = with straight upper run

$FL_B$  = with permitted sag

Further information ► **Design, page 1.12**

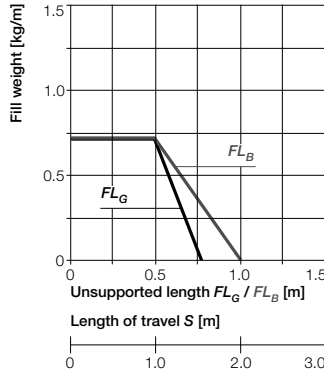
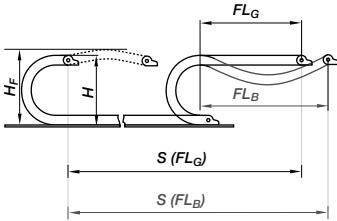

- $S$  = Length of travel
- $R$  = Bending radius
- $H$  = Nominal clearance height
- $H_F$  = Required clearance height
- $D$  = Overlength e-chain\*  
radius in final position
- $K = \pi \cdot R + \text{"safety"}$

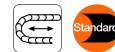
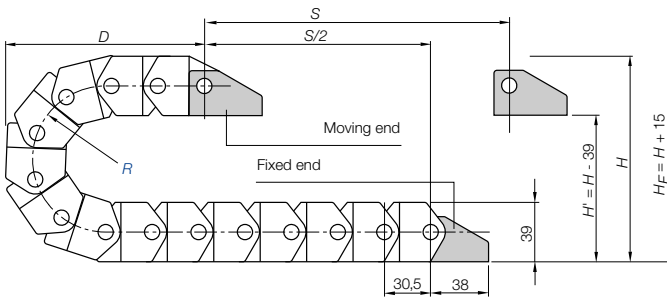

### Short travels - unsupported

Unsupported e-chains\* feature positive camber over short travels. This must be accounted for when specifying the clearance height  $H_F$ . Please consult igus® if space is particularly restricted.

**Pitch = 30,5 mm/link Links/m = 33 (1.006,5mm) Chain length =  $S/2 + K$**

R	040	060	075	100	125*
H	119	159	189	239	289
D	105	125	140	165	190
K	190	250	300	380	455

The required clearance height:  
 $H_F = H + 15$  mm  
(with 0,3 kg/m fill weight)

Speed / acceleration $FL_G$	max. 20 [m/s] / max. 200 [m/s <sup>2</sup> ]
Speed / acceleration $FL_B$	max. 3 [m/s] / max. 6 [m/s <sup>2</sup> ]
Gliding speed / acceleration (maximum)	max. 3 [m/s] / max. 10 [m/s <sup>2</sup> ]
Material (e-chain*) - permitted temperature °C	igumid NB / -40° up to +80° C
Material (mounting brackets)* - permitted temperature °C	igumid G / -40° up to +120° C
Flammability class (e-chain*), igumid NB	VDE 0304 IIC UL94 V2
Flammability class (mounting brackets), igumid G*	VDE 0304 IIC UL94 HB

\*Available in igumid NB upon request, please consult igus® for delivery time

### Technical Data



Details of material properties  
► page 1.38



easy chain®  
Inner height: 32 mm

Phone +49- (0) 22 03-96 49-800  
Fax +49- (0) 22 03-96 49-222



► page 3.5

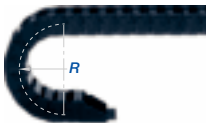
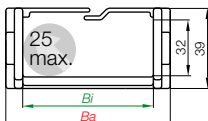

Part No. structure

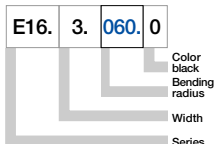

## Series E16 - split crossbar along the outer radius

Part No.	Bending radii						Weight [kg/m]
	Bi [mm]	Ba [mm]	R [mm]				
E16.2.□.0	23	37,5	060	075	100	≈ 0,51	
E16.3.□.0	36	50,5	060	075	100	≈ 0,57	
E16.4.□.0	48	62,5	060	075	100	≈ 0,62	
E16.5.□.0	63	78,5	060	075	100	≈ 0,75	
E16.6.□.0	80	95,5	060	075	100	≈ 0,83	
E16.7.□.0	100	115,3	060	075	100	≈ 0,91	

**Ba:** pin dimension approx. 0,3 - 0,7 mm wider

The bending radius **125** is available upon request.

Delivery time: approx. 3-4 weeks after receipt of order!

Supplement Part No. with required radius. Example: E16.3.□060.□0

0 = standard color, other colors ► page 1.39 · Pitch = 30,5 mm/link - Links/m = 33

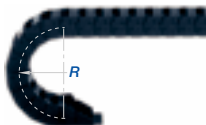
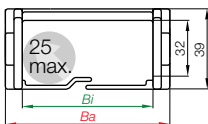

Part No. structure

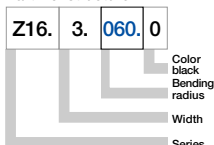

## Series Z16 - split crossbar along the inner radius

Part No.	Bending radii						Weight [kg/m]
	Bi [mm]	Ba [mm]	R [mm]				
Z16.2.□.0	23	37,5	060	075	100	≈ 0,51	
Z16.3.□.0	36	50,5	040	060	075	100	≈ 0,57
Z16.4.□.0	48	62,5	040	060	075	100	≈ 0,62
Z16.5.□.0	63	78,5	060	075	100	≈ 0,75	
Z16.6.□.0	80	95,5	060	075	100	≈ 0,83	
Z16.7.□.0	100	115,3	060	075	100	≈ 0,91	

**Ba:** pin dimension approx. 0,3 - 0,7 mm wider

The bending radius **125** is available upon request.

Delivery time: approx. 3-4 weeks after receipt of order!

Supplement Part No. with required radius. Example: Z16.3.□060.□0

0 = standard color, other colors ► page 1.39 · Pitch = 30,5 mm/link - Links/m = 33





**Polymer, one-piece**

- One-piece mounting bracket
- Corrosion-resistant
- Available preassembled
- Inner and outer attachment possible
- Available with integrated strain relief tiwrap plates
- 90° \* not for Series Z16

Moving end with bore  
(outer link) 117...1P(Z)

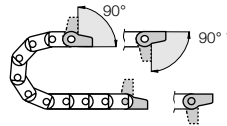

117...2P(Z) Fixed end  
with pin (inner link)

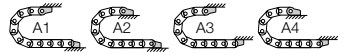

Possible installation conditions for assembled mounting brackets ▶ Order example "preassembled" below

117...1P(Z)

Moving end

117...2P(Z)

Fixed end

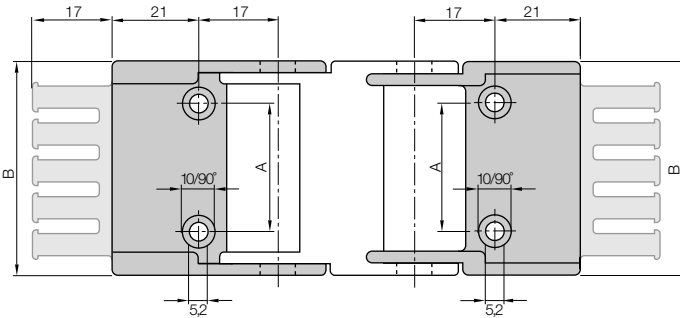

**Dimensions and order configurations**

Strain relief is possible on the moving end and/or the fixed end.

**Part No. structure**

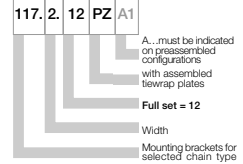

Full set, for both ends:

117. 2. 12 PZ +tiwrap plate

Single-part order:

117. 2. 1 PZ +tiwrap plate

Mounting bracket with bore

117. 2. 2 PZ +tiwrap plate

Mounting bracket with pin

For e-chain*	Part No. full set with tiwrap plate	Part No. full set without tiwrap plate	Number of teeth	Dim. A [mm]	Dim. B [mm]
E16-Z16.2. ▶	117. 2. 12PZ	117. 2. 12P	3	12	35,5
E16-Z16.3. ▶	117. 3. 12PZ	117. 3. 12P	4	25	48,5
E16-Z16.4. ▶	117. 4. 12PZ	117. 4. 12P	5	37	60,5
E16-Z16.5. ▶	117. 5. 12PZ	117. 5. 12P	6	48	76,0
E16-Z16.6. ▶	117. 6. 12PZ	117. 6. 12P	8	65	93,0
E16-Z16.7. ▶	117. 7. 12PZ	117. 7. 12P	10	85	113,0

Please add the Part No. with the requested index - e.g. 117. 2. 12PZ

For the preassembled mode please add the index A1...A4 e.g. 117. 2. 12PZ A1



**Quicksnap** - the complete, detachable mounting unit, available upon request



**Quickfix** - mounting bracket with dowel, available upon request

**Additional Features**



● ● ● Price index

**IPA Qualification Certificate:**  
Air Cleanless Class ISO Class 2  
(at v = 1 m/s) upon request

**UL94-V2**  
classifications

**Torsional**  
motion possible

**Special equipment:**  
Electrically conductive ESD/ATEX  
version upon request

- ① Limited torsion tolerance
- ② Large pins for long service life
- ③ Cable-friendly interior
- ④ Integrated strain relief option
- ⑤ "E" Series features split crossbar along the outer radius
- ⑥ "Z" Series features split crossbar along the inner radius
- ⑦ Dirt-repellent exterior
- ⑧ Very easy to fill
- ⑨ 1-, 2- or 3-chamber system available
- ⑩ The patented push-button principle holds the links together



Just push the cables into the e-chain® with your thumb - and it's ready

**+**  
When to use the Series E26/Z26:

- If filling is required without opening and closing lids
- If price is an issue
- If quiet operation is required

**-**  
When not to use it:

- For applications with very high loads and long unsupported travel lengths
  - ▶ Series 2600/2650/2680/2700 E2/000, page 5.182
- If an e-chain® is needed with a high locking crossbar
  - ▶ Series 2600/2650/2680/2700 E2/000, page 5.182

**Order example complete e-chain®**  
Please indicate chain-lengths or number of links Example: 1 m or 18 links

1 m E26.07.150.0

e-chain®

1 set 2607.34PZB

Mounting bracket



### Unsupported length

$FL_G$  = with straight upper run

$FL_B$  = with permitted sag

Further information ► Design, page 1.12

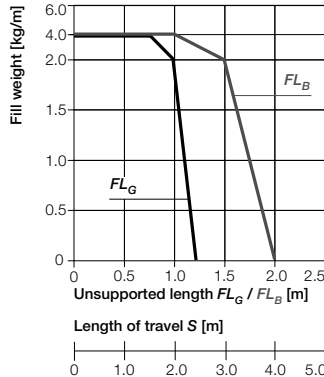
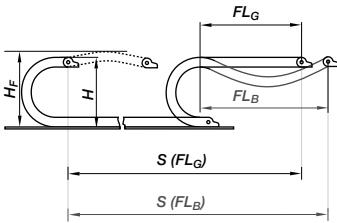

- $S$  = Length of travel
- $R$  = Bending radius
- $H$  = Nominal clearance height
- $H_F$  = Required clearance height
- $D$  = Overlength e-chain\* radius in final position
- $K = \pi \cdot R + \text{"safety"}$

#### Other installation methods

- Vertical, hanging  $\leq 10$  m
- Vertical, standing  $\leq 1,5$  m
- Side mounted, un supp.  $\leq 0,5$  m
- Rotary requires further calculation
- Unsupported length of upper run = upon request

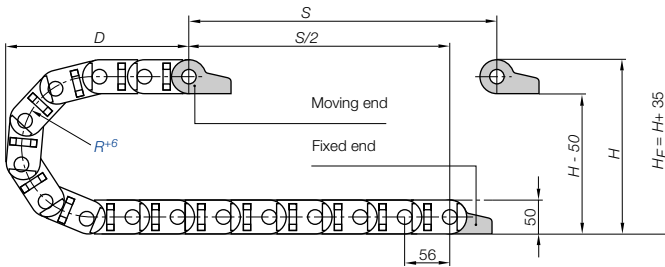

Pitch = 56 mm/link    Links/m = 18 (1.008 mm)    Chain length =  $S/2 + K$

R	063	075	100	125	150	175	200	250
H +5	176	200	250	300	350	400	450	550
D	172	184	209	234	259	284	309	359
K	310	350	430	505	585	665	745	900

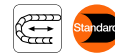

### Short travels - unsupported

Unsupported e-chains\* feature positive camber over short travels. This must be accounted for when specifying the clearance height  $H_F$ . Please consult igus\* if space is particularly restricted.

The required clearance height:  
 $H_F = H + 35$  mm  
 (with 2,0 kg/m fill weight)

Speed / acceleration $FL_G$	max. 20 [m/s] / max. 200 [m/s <sup>2</sup> ]
Speed / acceleration $FL_B$	max. 3 [m/s] / max. 6 [m/s <sup>2</sup> ]
Gliding speed / acceleration (maximum)	max. 3 [m/s] / max. 10 [m/s <sup>2</sup> ]
Material (e-chain)* - permitted temperature °C	igumid NB / -40° up to +80° C
Material (mounting brackets)* - permitted temperature °C	igumid G / -40° up to +120° C
Flammability class (e-chain)*, igumid NB	VDE 0304 IIC UL94 V2
Flammability class (mounting brackets), igumid G*	VDE 0304 IIC UL94 HB

\*Available in igumid NB upon request, please consult igus\* for delivery time

### Technical Data



Details of material properties  
 ► page 1.38

36,5

easy chain®  
 Inner height: 36,5 mm

Phone +49- (0) 22 03-96 49-800  
 Fax +49- (0) 22 03-96 49-222



► page 3.5



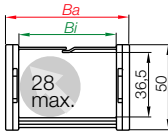

Series E26 - split crossbar along the outer radius

Part No.	$B_i$ [mm]	$B_a$ [mm]	$R$ [mm]	Bending radii	Weight [kg/m]
E26.07.	<input type="text" value="0"/>	75	92	<input type="text" value="063"/> <input type="text" value="075"/> <input type="text" value="100"/> <input type="text" value="125"/> <input type="text" value="150"/> <input type="text" value="175"/> <input type="text" value="200"/> <input type="text" value="250"/>	≈ 0,96

**Ba:** pin dimension approx. 0,3 - 0,5 mm wider!

Supplement Part No. with required radius. Example: E26.07..0

0 = standard color, other colors ► page 1.39 · Pitch = 56 mm/link - Links/m = 18

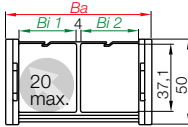

Series E26 - split crossbar along the outer radius with 2-chamber system

Part No.	$B_i$ [mm]	$B_a$ [mm]	$R$ [mm]	Bending radii	Weight [kg/m]
E26.2/45.	<input type="text" value="0"/>	48/48	117	<input type="text" value="063"/> <input type="text" value="075"/> <input type="text" value="100"/> <input type="text" value="125"/> <input type="text" value="150"/> <input type="text" value="175"/> <input type="text" value="200"/> <input type="text" value="250"/>	≈ 1,14

**Ba:** pin dimension approx. 0,3 - 0,5 mm wider!

Supplement Part No. with required radius. Example: E26.2/45..0

0 = standard color, other colors ► page 1.39 · Pitch = 56 mm/link - Links/m = 18

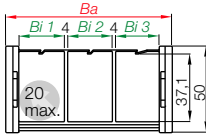

Series E26 - split crossbar along the outer radius with 3-chamber system

Part No.	$B_i$ [mm]	$B_a$ [mm]	$R$ [mm]	Bending radii	Weight [kg/m]
E26.3/45.	<input type="text" value="0"/>	47/48/47	167	<input type="text" value="063"/> <input type="text" value="075"/> <input type="text" value="100"/> <input type="text" value="125"/> <input type="text" value="150"/> <input type="text" value="175"/> <input type="text" value="200"/> <input type="text" value="250"/>	≈ 1,30

**Ba:** pin dimension approx. 0,3 - 0,5 mm wider!

Supplement Part No. with required radius. Example: E26.3/45..0

0 = standard color, other colors ► page 1.39 · Pitch = 56 mm/link - Links/m = 18

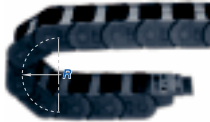

Part No. structure

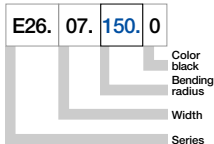

Series Z26 - split crossbar along the inner radius

Part No.	Bi [mm]	Ba [mm]	R [mm]	Bending radii	Weight [kg/m]
Z26.07. <input type="text"/> .0	75	92	063	075 100 125 150 175 200 250	≈ 0,96

Ba: pin dimension approx. 0,3 - 0,5 mm wider!

Supplement Part No. with required radius. Example: Z26.07..0

0 = standard color, other colors ▶ page 1.39 · Pitch = 56 mm/link - Links/m = 18

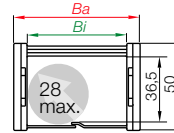

Series Z26 - split crossbar along the inner radius with 2-chamber system

Part No.	Bi [mm]	Ba [mm]	R [mm]	Bending radii	Weight [kg/m]
Z26.2/45. <input type="text"/> .0	48/48	117	063	075 100 125 150 175 200 250	≈ 1,14

Ba: pin dimension approx. 0,3 - 0,5 mm wider!

Supplement Part No. with required radius. Example: Z26.2/45..0

0 = standard color, other colors ▶ page 1.39 · Pitch = 56 mm/link - Links/m = 18

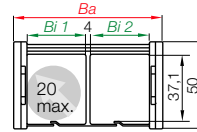

Series Z26 - split crossbar along the inner radius with 3-chamber system

Part No.	Bi [mm]	Ba [mm]	R [mm]	Bending radii	Weight [kg/m]
Z26.3/45. <input type="text"/> .0	47/48/47	167	063	075 100 125 150 175 200 250	≈ 1,30

Ba: pin dimension approx. 0,3 - 0,5 mm wider!

Supplement Part No. with required radius. Example: Z26.3/45..0

0 = standard color, other colors ▶ page 1.39 · Pitch = 56 mm/link - Links/m = 18

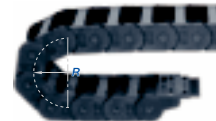
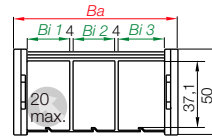

Part No. structure

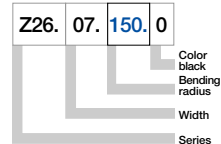

easy chain®  
Inner height: 36,5 mm

Phone +49- (0) 22 03-96 49-800  
Fax +49- (0) 22 03-96 49-222



▶ page 3.5

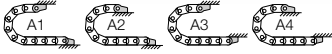

Possible installation conditions for assembled mounting brackets ▶ Order example "preassembled" below

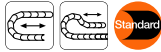

### The Standard - option polymer - pivoting

- Recommended for unsupported and gliding applications
- Well suited for tight installation conditions
- Strain relief with detachable tiwrap plates
- Variable traverse angle for flexible assembly
- The twistability of the e-chain® and the option to assemble the mounting brackets on the fixed end and/or the moving end, enable various installation options

Moving end with bore (outer link) 26...3PZ(B)

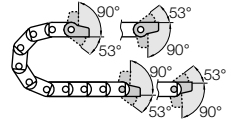

26...4PZ(B) Fixed end with pin (inner link)

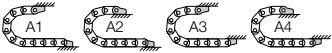

Possible installation conditions for assembled mounting brackets ▶ Order example "preassembled" below

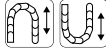

### Option polymer - locking

- Recommended for unsupported and gliding applications
- Furthermore:**
- At very high speed and/or acceleration
  - If space is limited for height (the  $H_F$  measurement)
  - The twistability of the e-chain® and the option to assemble the mounting brackets on the fixed end and/or the moving end, enable various installation options

Moving end with bore (outer link) 26...1PZ(B)

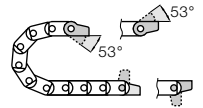

26...2PZ(B) Fixed end with pin (inner link)

## Dimensions and order configurations

Strain relief is possible on the moving end and/or the fixed end.

### Part No. structure (pivoting)

2607. 34 PZB A1

A... must be indicated on preassembled configurations with assembled tiwrap plates  
Full set pivoting = 34  
Mounting brackets for selected chain type

Full set, for both ends:  
2607. 34 PZB +tiwrap plate

Single-part order:  
2607. 3 PZB +tiwrap plate

Mounting bracket with bore  
2607. 4 PZB +tiwrap plate

Mounting bracket with pin

### Part No. structure (locking)

2607. 12 PZB A1

A... must be indicated on preassembled configurations with assembled tiwrap plates  
Full set locking = 12  
Mounting brackets for selected chain type

Full set, for both ends:  
2607. 12 PZB +tiwrap plate

Single-part order:  
2607. 1 PZB +tiwrap plate

Mounting bracket with bore  
2607. 2 PZB +tiwrap plate

Mounting bracket with pin

26...3PZ(B) Standard! (pivoting)

26...1PZ(B) (locking)

Moving end

Standard! (pivoting) 26...4PZ(B)

(locking) 26...2PZ(B)

Fixed end

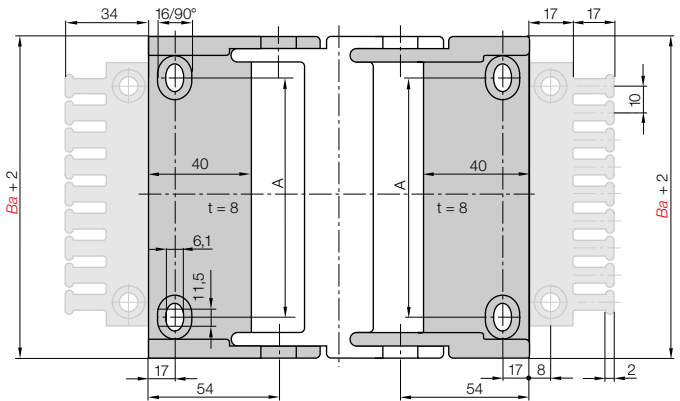

For e-chain®	Part No. full set with tiwrap plate	Part No. tiwrap plate + 10 cable tiwraps	Part No. full set without tiwrap plate	Number of teeth	Dim. A [mm]
E26-Z26.07	▶ 2607. [ ] PZB	2607. [ ] PZBK1	2607. [ ] PZ	7	55
E26-Z26.2/45	▶ 2610. [ ] PZB	2610. [ ] PZBK1	2610. [ ] PZ	10	80
E26-Z26.3/45	▶ 2615. [ ] PZB	2615. [ ] PZBK1	2615. [ ] PZ	15	130

Please add the Part No. with the requested index - 34 for the pivoting configuration

e.g. 2607. 34 PZB or 12 for the locking configuration e.g. 2607. 12 PZB

For the preassembled mode please add the index A1...A4 e.g. 2607. 34 PZB A1

### Strain relief for polymer mounting brackets (pivoting or locking)

The strain relief tiewrap plate can be directly snapped onto the mounting bracket. After bolting the mounting brackets to the machine, the strain relief tiewrap plates are also firmly connected to the base. They do not need to be bolted on separately. Cable tiewraps secure the tiewrap plate "teeth" and the cable to provide proper strain relief and save time. **Details ▶ chapter 10**



Tiewrap plate	No. of teeth <i>n</i>	Dim. C [mm]	Dim. B [mm]	Center bore
3050.ZB	5	50	30	-
3075.ZB	7	75	55	-
3100.ZB	10	100	80	-
3115.ZB	11	115	95	-
3125.ZB	12	125	105	-
3150.ZB	15	150	130	-
3175.ZB	17	175	155	-
3200.ZB	20	200	180	+
3225.ZB	22	225	205	+
3250.ZB	25	250	230	+

(- = no / + = yes)

### Tiewrap plate as individual part

As individual component screwed on or can be plugged in the mounting brackets. **Details ▶ chapter 10**

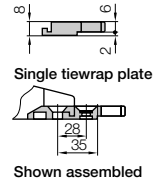
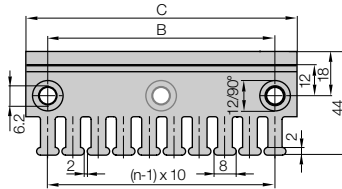

### Cable tiewraps as individual part

Cable tiewraps 100 pieces/bag	Width x length	Max. Ø	Tensile strength
CFB.001	4,8 x 150 mm	36 mm	222 N



Other strain relief elements - optional ▶ chapter 10



▶ chapter 10



▶ page 3.5

easy chain®  
Inner height: 36,5 mm

Phone +49- (0) 22 03-96 49-800  
Fax +49- (0) 22 03-96 49-222



Price index



IPA Qualification Certificate:  
Air Cleanable Class ISO Class 2  
(at v = 1 m/s) upon request



UL94-V2  
classifications



Torsional  
motion possible



Special equipment:  
Electrically conductive ESD/ATEX  
version upon request



Just push the cables into the e-chain®  
with your thumb - and it's ready



When to use the Series E300/Z300:

- If filling is required without opening and closing lids
- If price is an issue
- If quiet operation is required



When not to use it:

- For applications with very high loads and long unsupported travel lengths
- Series 3400/3450/3480/3500  
E2/000, page 5.204

- ① Limited torsion tolerance
- ② Large pins for long service life
- ③ Cable-friendly interior
- ④ Integrated strain relief option
- ⑤ "E" Series features split crossbar along the outer radius
- ⑥ "Z" Series features split crossbar along the inner radius
- ⑦ Dirt-repellent exterior
- ⑧ Very easy to fill
- ⑨ Interior separation possible
- ⑩ 1-, 2- or 3-chamber system available
- ⑪ The patented push-button principle holds the links together

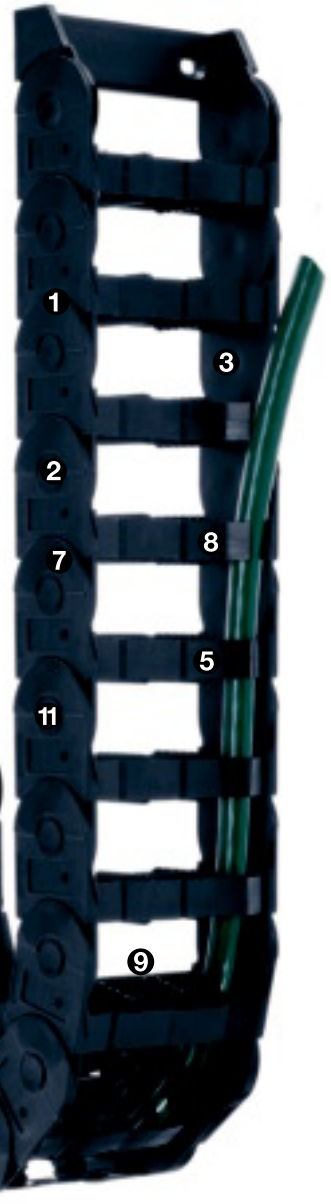
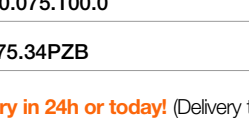
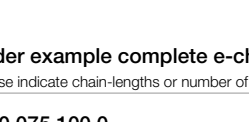

Order example complete e-chain®

Please indicate chain-lengths or number of links Example: 1 m or 15 Links

1 m E300.075.100.0



e-chain®

1 set 3075.34PZB



Mounting bracket



### Unsupported length

$FL_G$  = with straight upper run

$FL_B$  = with permitted sag

Further information ► Design, page 1.12

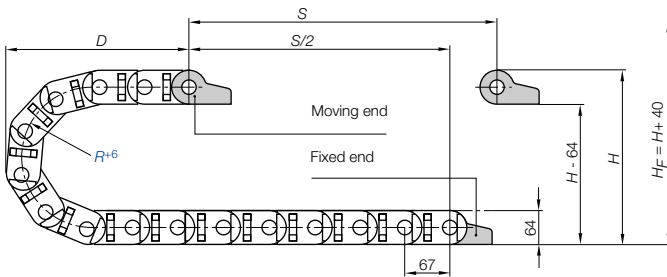
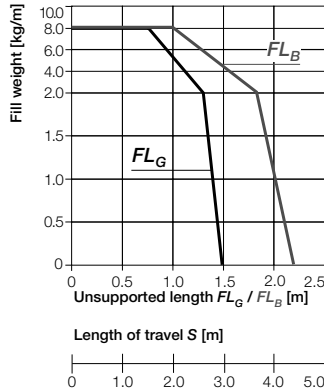
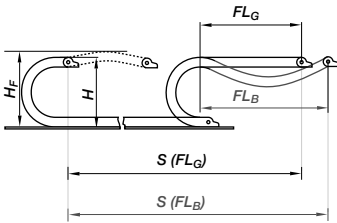

Pitch = 67 mm/link    Links/m = 15 (1.005 mm)    Chain length =  $S/2 + K$

R	075	100	125	150	200	250	300
H +5	214	264	314	364	464	564	664
D	208	233	258	283	333	383	433
K	370	450	530	610	765	920	1080

- S = Length of travel
- R = Bending radius
- H = Nominal clearance height
- $H_F$  = Required clearance height
- D = Overlength e-chain\*  
radius in final position
- $K = \pi \cdot R + \text{"safety"}$

#### Other installation methods

- Vertical, hanging  $\leq 10$  m
- Vertical, standing  $\leq 1,5$  m
- Side mounted, un supp.  $\leq 0,5$  m
- Rotary requires further calculation
- Unsupported length of upper run = upon request

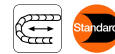

### Short travels - unsupported

Unsupported e-chains\* feature positive camber over short travels. This must be accounted for when specifying the clearance height  $H_F$ . Please consult igus\* if space is particularly restricted.

The required clearance height:  
 $H_F = H + 40$  mm  
(with 2,5 kg/m fill weight)

Speed / acceleration $FL_G$	max. 20 [m/s] / max. 200 [m/s <sup>2</sup> ]
Speed / acceleration $FL_B$	max. 3 [m/s] / max. 6 [m/s <sup>2</sup> ]
Gliding speed / acceleration	max. 3 [m/s] / max. 10 [m/s <sup>2</sup> ]
Material (e-chain)* - permitted temperature °C	igumid NB / -40° up to +80° C
Material (mounting brackets)* - permitted temperature °C	igumid G / -40° up to +120° C
Flammability class (e-chain)*, igumid NB	VDE 0304 IIC UL94 V2
Flammability class (mounting brackets), igumid G*	VDE 0304 IIC UL94 HB

\*Available in igumid NB upon request, please consult igus\* for delivery time

### Technical Data



Details of material properties  
► page 1.38

48,5

easy chain®  
Inner height: 48,5 mm

Phone +49- (0) 22 03-96 49-800  
Fax +49- (0) 22 03-96 49-222



► page 3.5



igus® e-chainsystems®

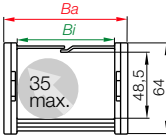

Series E300 - split crossbar along the outer radius

Part No.	Bi [mm]	Ba [mm]	R [mm]	Bending radii	Weight [kg/m]
E300.075. <input type="text" value="0"/>	75	95	<input type="text" value="075"/>	<input type="text" value="100"/> <input type="text" value="125"/> <input type="text" value="150"/> <input type="text" value="200"/> <input type="text" value="250"/> <input type="text" value="300"/>	≈ 1,60

Ba: pin dimension approx. 0,3 - 0,5 mm wider!

Supplement Part No. with required radius. Example: E300.075. .0

0 = standard color, other colors ▶ page 1.39 · Pitch = 67 mm/link - Links/m = 15

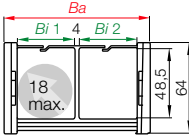

Series E300 - split crossbar along the outer radius with 2-chamber system

Part No.	Bi [mm]	Ba [mm]	R [mm]	Bending radii	Weight [kg/m]
E300.2/45. <input type="text" value="0"/>	48/48	120	<input type="text" value="075"/>	<input type="text" value="100"/> <input type="text" value="125"/> <input type="text" value="150"/> <input type="text" value="200"/> <input type="text" value="250"/> <input type="text" value="300"/>	≈ 1,78

Ba: pin dimension approx. 0,3 - 0,5 mm wider!

Supplement Part No. with required radius. Example: E300.2/45. .0

0 = standard color, other colors ▶ page 1.39 · Pitch = 67 mm/link - Links/m = 15

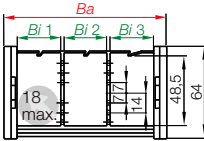

Series E300 - split crossbar along the outer radius with 3-chamber system

Part No.	Bi [mm]	Ba [mm]	R [mm]	Bending radii	Weight [kg/m]
E300.3/45. <input type="text" value="0"/>	47/46/47	170	<input type="text" value="075"/>	<input type="text" value="100"/> <input type="text" value="125"/> <input type="text" value="150"/> <input type="text" value="200"/> <input type="text" value="250"/> <input type="text" value="300"/>	≈ 1,92

Ba: pin dimension approx. 0,3 - 0,5 mm wider!

Supplement Part No. with required radius. Example: E300.3/45. .0

0 = standard color, other colors ▶ page 1.39 · Pitch = 1 m = 15 Links

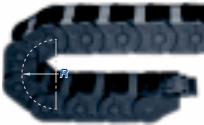

Part No. structure

E300.075. .



Phone +49- (0) 22 03-96 49-800  
Fax +49- (0) 22 03-96 49-222

igus® GmbH  
51147 Cologne

Internet: www.igus.eu  
E-mail: info@igus.de

Series Z300 - split crossbar along the inner radius

Part No.	Bi [mm]	Ba [mm]	R [mm]	Bending radii	Weight [kg/m]
Z300.075.□.0	75	95	075	100 125 150 200 250 300	≈1,60

Ba: pin dimension approx. 0,3 - 0,5 mm wider!

Supplement Part No. with required radius. Example: Z300.075.100.0

0 = standard color, other colors ▶ page 1.39 · Pitch = 67 mm/link - Links/m = 15

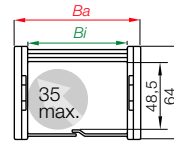

Series Z300 - split crossbar along the inner radius with 2-chamber system

Part No.	Bi [mm]	Ba [mm]	R [mm]	Bending radii	Weight [kg/m]
Z300.2/45.□.0	48/48	120	075	100 125 150 200 250 300	≈ 1,78

Ba: pin dimension approx. 0,3 - 0,5 mm wider!

Supplement Part No. with required radius. Example: Z300.2/45.100.0

0 = standard color, other colors ▶ page 1.39 · Pitch = 67 mm/link - Links/m = 15

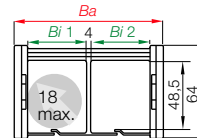

Series Z300 - split crossbar along the inner radius with 3-chamber system

Part No.	Bi [mm]	Ba [mm]	R [mm]	Bending radii	Weight [kg/m]
Z300.3/45.□.0	47/46/47	170	075	100 125 150 200 250 300	≈ 1,92

Ba: pin dimension approx. 0,3 - 0,5 mm wider!

Supplement Part No. with required radius. Example: Z300.3/45.100.0

0 = standard color, other colors ▶ page 1.39 · Pitch = 67 mm/link - Links/m = 15

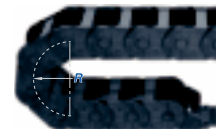
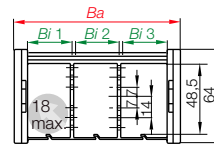

Part No. structure

Z300.075.	100.	0
-----------	------	---

Color  
black  
Bending radius  
Width  
Series

easy chain®  
Inner height: 48,5 mm

Phone +49- (0) 22 03-96 49-800  
Fax +49- (0) 22 03-96 49-222

Optional shelving for E300.3/45 · Z300.3/45

- Shelving enables subdivision of the inner space of the e-chain® Series E300.3/45 and Z300.3/45. Shelves are only used when a horizontal subdivision is required.
- In standard configurations, shelves are installed in every other link.

Shelves	Weight [kg]
unassembled	386.54
assembled	387.54

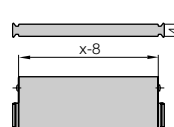
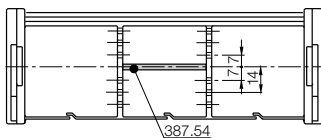



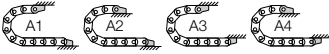

Possible installation conditions for assembled mounting brackets ▶ Order example "preassembled" below

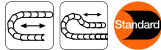

### The Standard - option polymer - pivoting

- Recommended for unsupported and gliding applications
- Well suited for tight installation conditions
- Strain relief with detachable tiwrap plates
- Variable traverse angle for flexible assembly
- The twistability of the e-chain® and the option to assemble the mounting brackets on the fixed end and/or the moving end, enable various installation options

Moving end with bore  
(outer link) 3...3PZ(B)

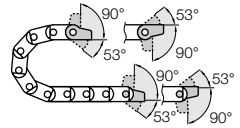

3...4PZ(B) Fixed end  
with pin (inner link)

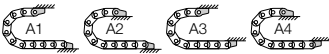

Possible installation conditions for assembled mounting brackets ▶ Order example "preassembled" below

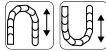

### Option polymer - locking

- Recommended for unsupported and gliding applications
- Furthermore:
- At very high speed and/or acceleration
  - If space is limited for height (the  $H_F$  measurement)
  - The twistability of the e-chain® and the option to assemble the mounting brackets on the fixed end and/or the moving end, enable various installation options

Moving end with bore  
(outer link) 3...1PZ(B)

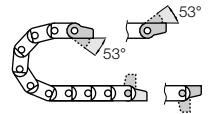

3...2PZ(B) Fixed end  
with pin (inner link)

## Dimensions and order configurations

Strain relief is possible on the moving end and/or the fixed end.

### Part No. structure (pivoting)

3075. 34 PZB A1

A... must be indicated on preassembled configurations with assembled tiwrap plates. Full set pivoting = 34. Mounting brackets for selected chain type.

Full set, for both ends:

3075. 34 PZB +tiwrap plate

Single-part order:

3075. 3 PZB +tiwrap plate

Mounting bracket with bore

3075. 4 PZB +tiwrap plate

Mounting bracket with pin

### Part No. structure (locking)

3075. 12 PZB A1

A... must be indicated on preassembled configurations with assembled tiwrap plates. Full set locking = 12. Mounting brackets for selected chain type.

Full set, for both ends:

3075. 12 PZB +tiwrap plate

Single-part order:

3075. 1 PZB +tiwrap plate

Mounting bracket with bore

3075. 2 PZB +tiwrap plate

Mounting bracket with pin

3...3PZ(B) Standard! (pivoting)

3...1PZ(B) (locking)

Moving end

Standard! (pivoting) 3...4PZ(B)

(locking) 3...2PZ(B)

Fixed end

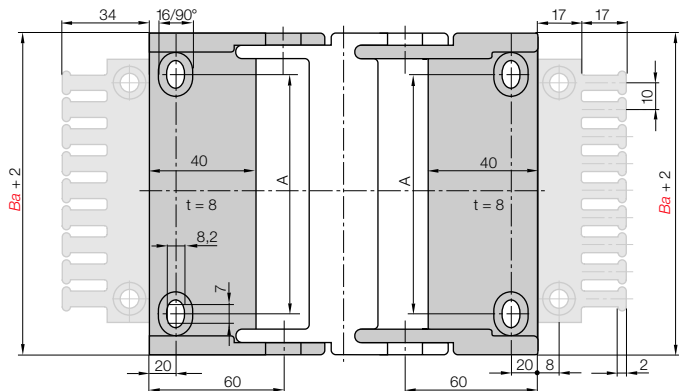

For e-chain®	Part No. full set with tiwrap plate	Part No. tiwrap plate + 10 cable tiwraps	Part No. full set without tiwrap plate	Number of teeth	Dim. A [mm]
E300/Z300.075	3075. <input type="checkbox"/> PZB	3075. <input type="checkbox"/> PZBK1	3075. <input type="checkbox"/> PZ	7	53
E300/Z300.2/45	▶ 3100. <input type="checkbox"/> PZB	3100. <input type="checkbox"/> PZBK1	3100. <input type="checkbox"/> PZ	10	78
E300/Z300.3/45	▶ 3150. <input type="checkbox"/> PZB	3150. <input type="checkbox"/> PZBK1	3150. <input type="checkbox"/> PZ	15	128

Please add the Part No. with the requested index - 34 for the pivoting configuration

e.g. 3075. 34 PZB or 12 for the locking configuration e.g. 3075. 12 PZB

For the preassembled mode please add the index A1...A4 e.g. 3075. 34 PZB A1

### Strain relief for polymer mounting brackets (pivoting or locking)

The strain relief tiewrap plate can be directly snapped onto the mounting bracket. After bolting the mounting brackets to the machine, the strain relief tiewrap plates are also firmly connected to the base. They do not need to be bolted on separately. Cable tiewraps secure the tiewrap plate "teeth" and the cable to provide proper strain relief and save time. **Details ▶ chapter 10**



Tiewrap plate	No. of teeth <i>n</i>	Dim. C [mm]	Dim. B [mm]	Center bore
3050.ZB	5	50	30	-
3075.ZB	7	75	55	-
3100.ZB	10	100	80	-
3115.ZB	11	115	95	-
3125.ZB	12	125	105	-
3150.ZB	15	150	130	-
3175.ZB	17	175	155	-
3200.ZB	20	200	180	+
3225.ZB	22	225	205	+
3250.ZB	25	250	230	+

(- = no / + = yes)

### Tiewrap plate as individual part

As individual component screwed on or can be plugged in the mounting brackets. **Details ▶ chapter 10**

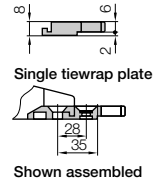
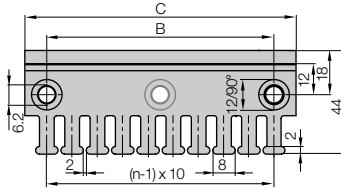

### Cable tiewraps as individual part

Cable tiewraps 100 pieces/bag	Width x length	Max. Ø	Tensile strength
CFB.001	4,8 x 150 mm	36 mm	222 N



Other strain relief elements - optional ▶ chapter 10

easy chain®  
Inner height: 48,5 mm

Phone +49- (0) 22 03-96 49-800  
Fax +49- (0) 22 03-96 49-222



▶ chapter 10



▶ page 3.5

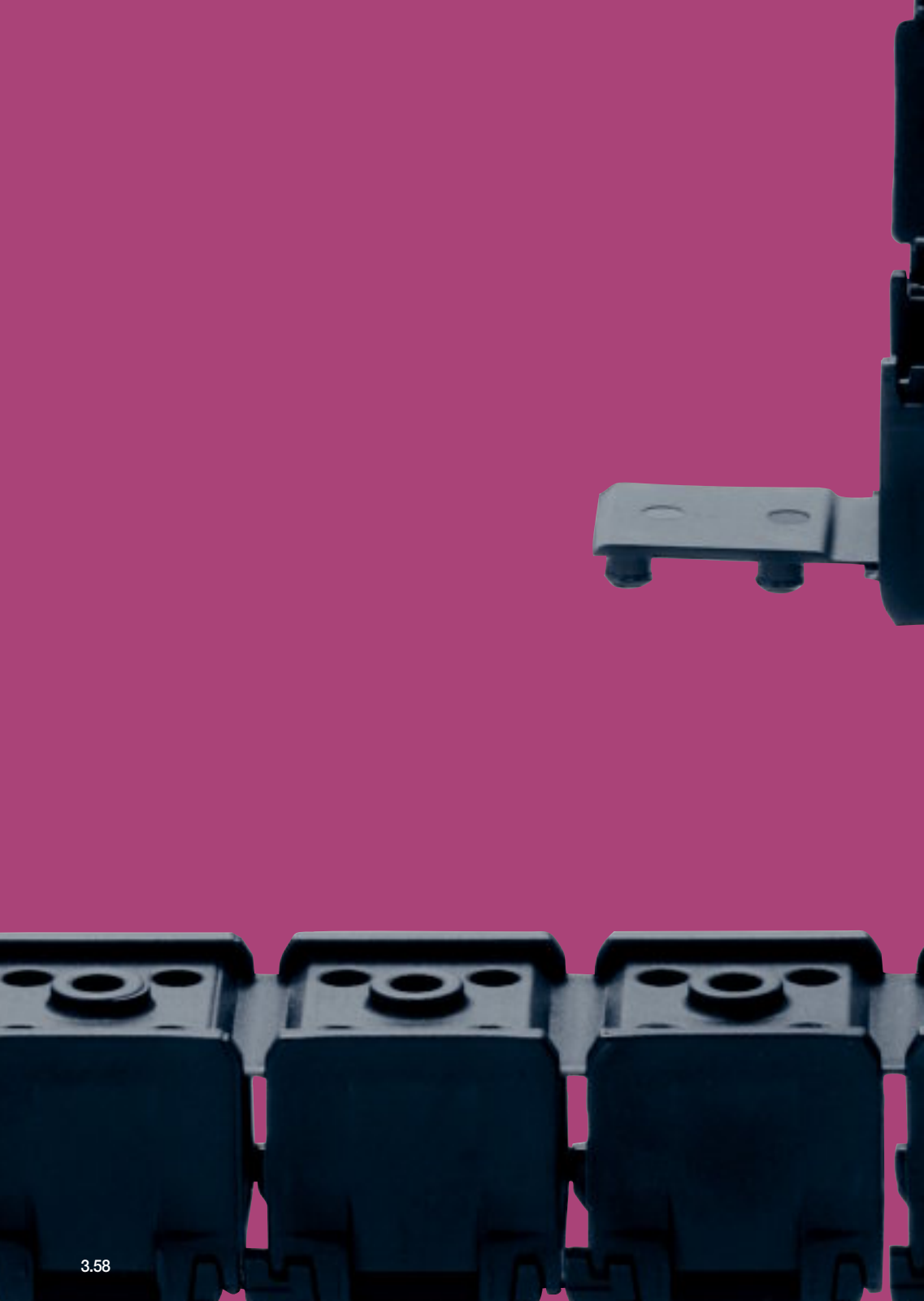

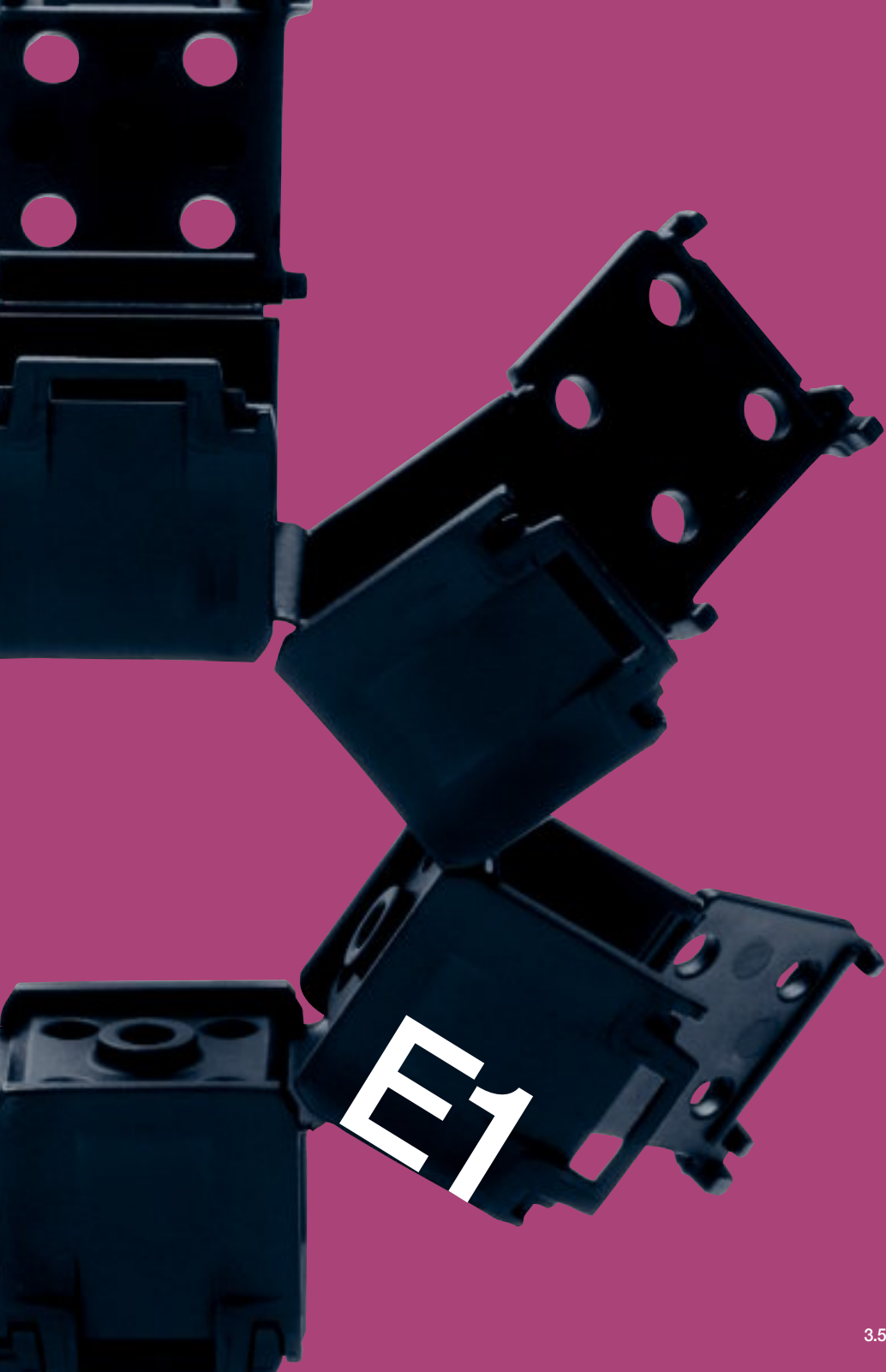

# E1- Modular, one-piece strip design for simple applications

E1: e-chain® modular, 1-piece strip designed for simple applications - The E1 design brings the benefits of an e-chain® to applications, where this solution previously was too expensive. E1 is more economic for higher volumes, quicker to assemble and still offers great control and protection for moving cables. The igus®-System E1 is very cost effective for high volumes and is especially ideal for automotive applications.

## Typical industries and applications

- Automotive
- Office Solutions and technology
- Automation
- Electric equipment
- Machine-building



UL94-V2  
classifications

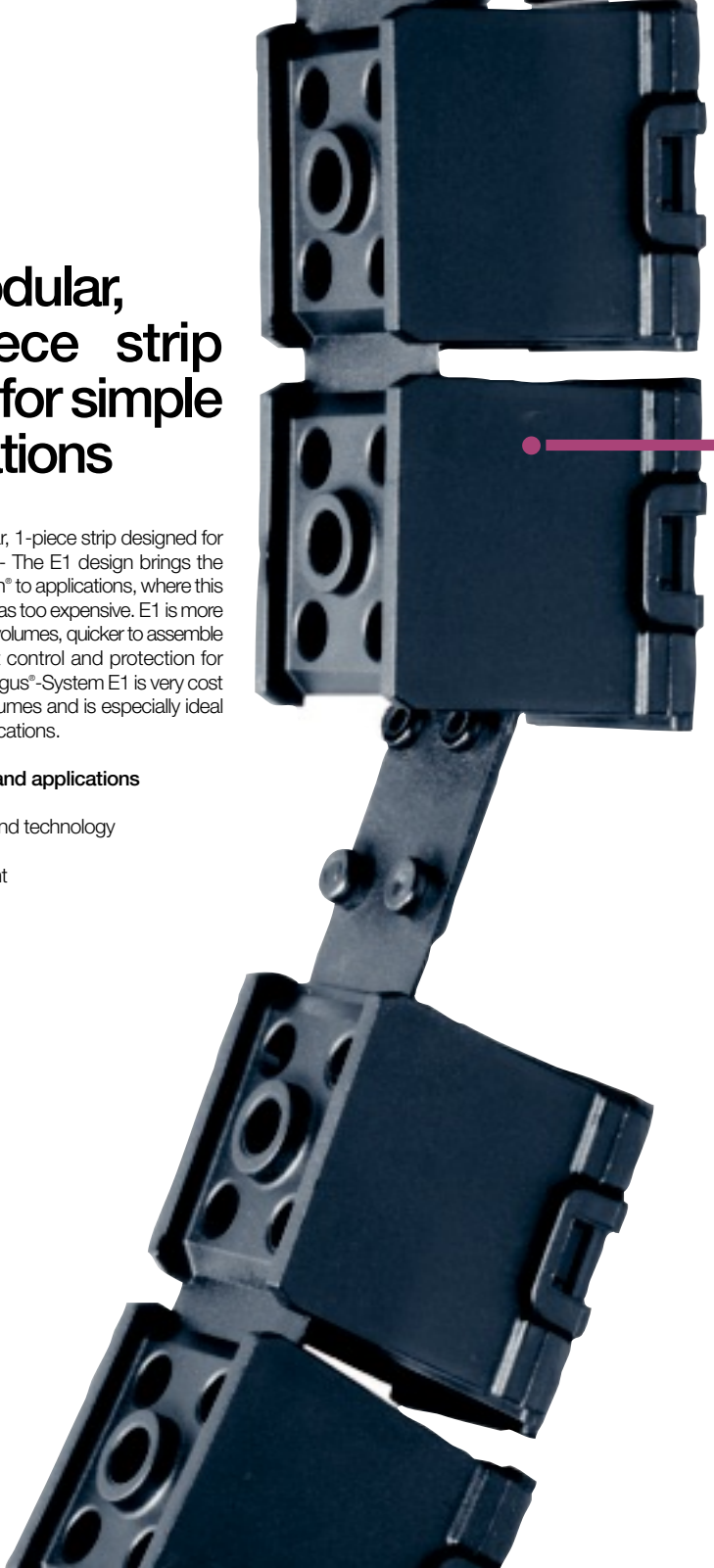

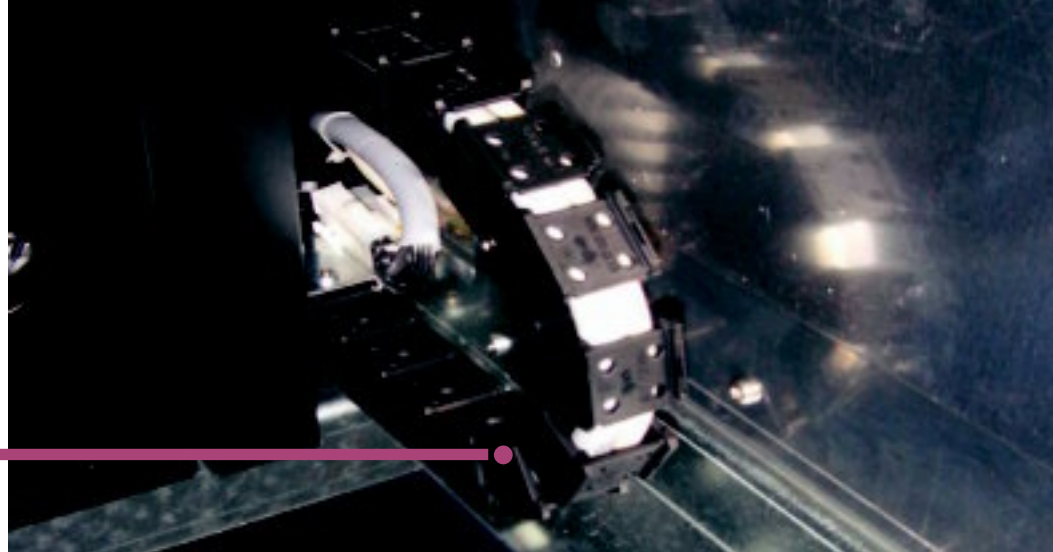

Harnessed igus® System E1 in a bottle deposit machine



Series E1.17.021.028 in an electric wheelchair -  
cably supply on the scissors lifting system



The igus®-System E1 is very cost-effective at high  
quantities and ideal for automotive applications



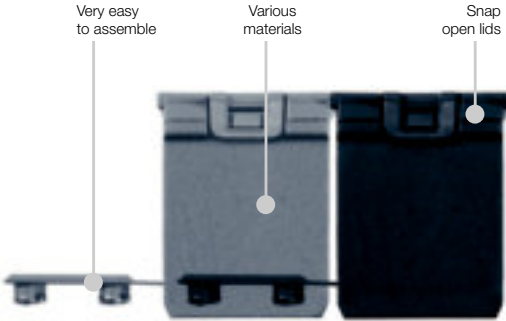

## Modular, 1-piece strip design for simple applications

- Economic solution for high volumes
- A universal and easily adaptable e-chain® concept
- E1: e-chain® on one strip
- Easy shortening/lengthening through molded-on, modular strip
- Easy to snap open
- Strip connectors
- Easy fixation at each end
- Various materials available
- You can find more technical data about the material, chemical resistance, temperatures ► [chapter design, from page 1.38](#)

### Selection table

Series	Inner height <i>hi</i> [mm]	Inner width <i>Bi</i> [mm]	Outer width <i>Ba</i> [mm]	Outer height <i>ha</i> [mm]	Bending radius <i>R</i> [mm]	Length part [mm]	Page
E1.10.013.	10	13	16,5	15,5	18	200	3.64
E1.17.021.	17	21	26	25	28	255	3.64
E1.17.031.	17	31	36	25	28	204	3.64
E1.17.044.	17	44	49	25	28	255	3.64
E1.18.015.*	18	15	20	26	28	127,5	3.64
E1.20.015.	20	15	22	27	28	250	3.64

**\*NEW** in this catalog



System E1 - e-chain® on one strip - snap-open along outer radius

To shorten | System E1



System E1 - e-chain® on one strip - easy to shorten....

To lengthen | System E1



.. and to lengthen





Price index

 UL94-V2  
 classifications

- ① Easy to shorten - separation at each segment
- ② Very easy to fill because of snap-open lids
- ③ Easy to lengthen - strips can simply be snapped together
- ④ Easy fastening through strip bore each link
- ⑤ Low-price e-chain®
- ⑥ Different materials and colors available upon request
- ⑦ Compact design with smooth outer contour
- ⑧ Strain relief option (clip-on bracket)
- ⑨ All lids snap open to the same side for easier, (Except E1.20 - to open from both sides), and possibly automated closing

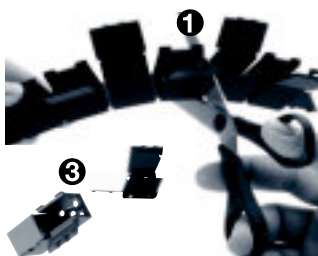

 System E1 - e-chain® on one strip -  
 easy to shorten and to lengthen

**When to use the Series E1:**

- If simple filling is required
- If an economical e-chain® is required
- If small assembly cost is required
- For lower duty or cycle life

**When not to use it:**

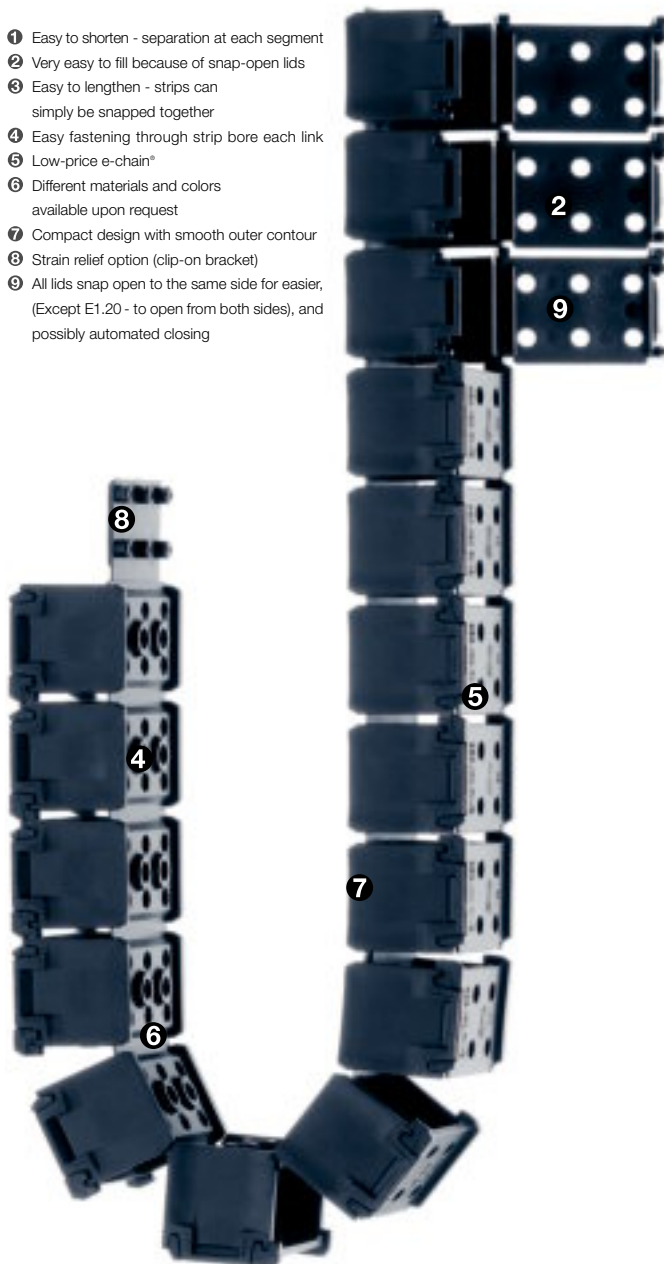
- High load applications
  - ▶ easy chain®, this chapter
  - ▶ zipper, chapter 4
- High cycle applications
  - ▶ easy chain®, this chapter
  - ▶ zipper, chapter 4



**Order example complete e-chain®**

Please indicate chain-lengths or number of links Example: 1 Band = 250 mm of length

1 m E1.17.021.028.0 (= 4 x 255 mm Band)

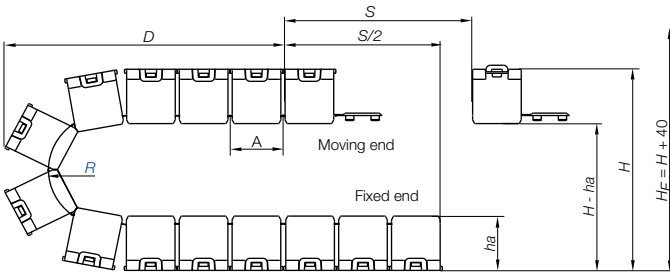

e-chain®



- S = Length of travel
- R = Bending radius
- H = Nominal clearance height
- H<sub>f</sub> = Required clearance height
- D = Overlength e-chain\*  
radius in final position
- K =  $\pi \cdot R + \text{"safety"}$

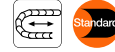

Pitch = see Dim. A Length part = see Dim. B (table below) Chain length =  $S/2 + K$

Bending radius for Series:				
	E1.10	E1.17	E1.18	E1.20
R	018	028	028	028
H	62	92	92	92
D	66	76	76	76
K	100	120	120	120

The required clearance height is  $H_f = H + 40 \text{ mm}$  · More radii upon request!

### Short travels - unsupported

Unsupported e-chains\* feature positive camber over short travels. This must be accounted for when specifying the clearance height  $H_f$ . Please consult igus\* if space is particularly restricted.

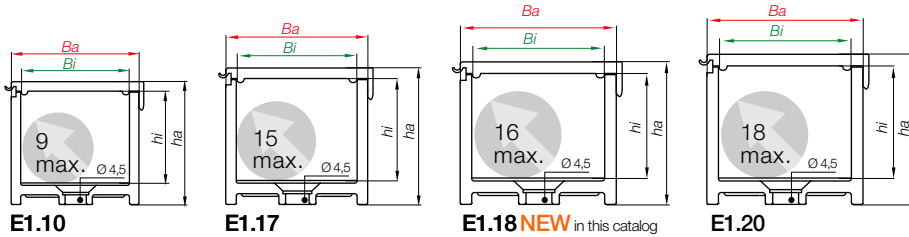

### Product Range - Series E1 - snap-open along outer radius

Part No.	Bi [mm]	Ba [mm]	hi [mm]	ha [mm]	R [mm]	Bending radii	A [mm]	B [mm]
E1.10.013.□.0	13	16,5	10	15,5	018		20	200
E1.17.021.□.0	21	26	17	25	028		25,5	255
E1.17.031.□.0	31	36	17	25	028		25,5	204
E1.17.044.□.0	44	49	17	25	028		25,5	255
E1.18.015.□.0	15	20	18	26	028		23,5	127,5
E1.20.015.□.0*	15	22	20	27	028		25	250

\* E1.20.015 - Lids to open reciprocally

Supplement Part No. with required radius. Example: E1.17.021.028.0

0 = standard color, other colors ▶ page 1.39

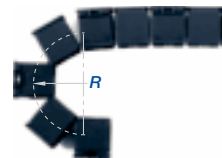

Part No. structure

E1.17.021.028.0

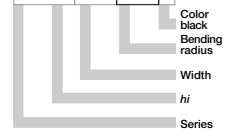

System E1  
Inner height: 10, 17, 18, 20 mm

Phone +49- (0) 22 03-96 49-800  
Fax +49- (0) 22 03-96 49-222





# snapchain





Price index

iF-Design-Award  
for snapchain-Design

### Typical industries and applications

- Switch cubicle construction
- Electrical equipment
- Computer cubicles
- Office furniture
- Wherever cables are moved now and then



- ① Fit cable assemblies quickly in bunches
- ② Adjust and change loops at any time
- ③ Well-suited to short lengths, ideally 5 - 10 links
- ④ Favorable alternative to complex hinged cable trays
- ⑤ Version TE14/TE26 can be opened along outer radius
- ⑥ Version TZ14/TZ26 can be opened along inner radius
- ⑦ Elegant design
- ⑧ Can be bent in 1 or 2 directions
- ⑨ Available in 2 sizes



#### When to use the snapchain Series :

- If simple filling is required
- If an economical e-chain is required
- If small assembly cost is required
- If an easy solution is required
- For minor number of travels



#### When not to use it:

- High load applications
  - ▶ easy chain®, this chapter
  - ▶ zipper, chapter 4
- High cycle applications
  - ▶ easy chain®, this chapter
  - ▶ zipper, chapter 4



Order example complete e-chain®

Please indicate chain-lengths or number of links Example: 1 m or 18 links

1 m TE26.120.100.0



e-chain®

**snapchain - TE14 / TZ14 - to be opened**

Part No.	R [mm]	Bending radii					
TE14.50.□.0*	028	038	048	075	100	125	
TZ14.50.□.0	028	038	048	075	100	125	

\*Available as RBR (Reverse bending radius) Part No. TE14.50.Radius/Radius

Supplement Part No. with required radius. Example: TE14.50.100.0

0 = standard color, other colors ▶ page 1.39 · Pitch = 30,5 mm/link - Links/m = 33

Pitch = 30,5 mm

Links/m = 33 (1.006,5 mm)

Chain length =  $s/2 + K$

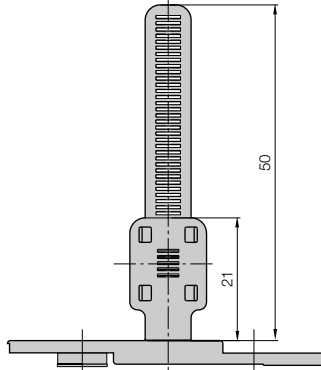
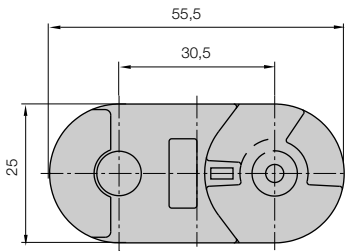

Part No. structure

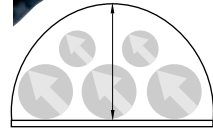
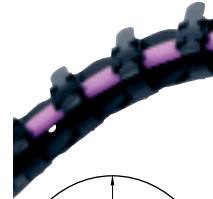
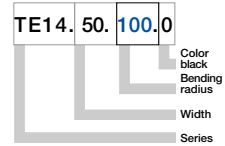

Cable package max.: 18 mm

snapchain

Phone +49- (0) 22 03-96 49-800  
Fax +49- (0) 22 03-96 49-222

**snapchain - TE26 / TZ26 - to be opened**

Part No.	R [mm]	Bending radii					
TE26.120.□.0*	063	075	100	125	150	200	
TZ26.120.□.0	063	075	100	125	150	200	

\*Available as RBR (Reverse bending radius) Part No. TE26.120.Radius/Radius

Supplement Part No. with required radius. Example: TE26.120.100.0

0 = standard color, other colors ▶ page 1.39 · Pitch = 56 mm/link - Links/m = 18

Pitch = 56 mm

Links/m = 18 (1.008 mm)

Chain length =  $s/2 + K$

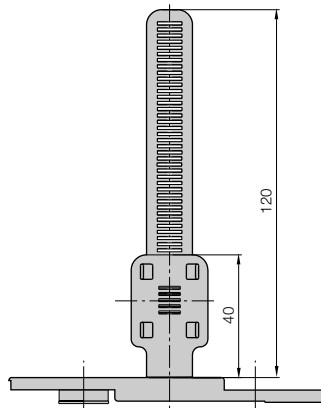
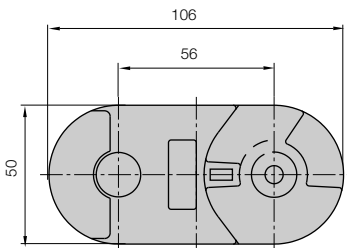

Part No. structure

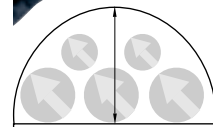
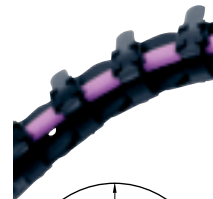
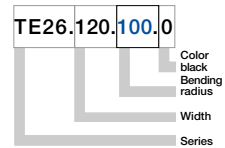

Cable package max.: 47 mm

